

# VOLKSWAGEN

AKTIENGESELLSCHAFT

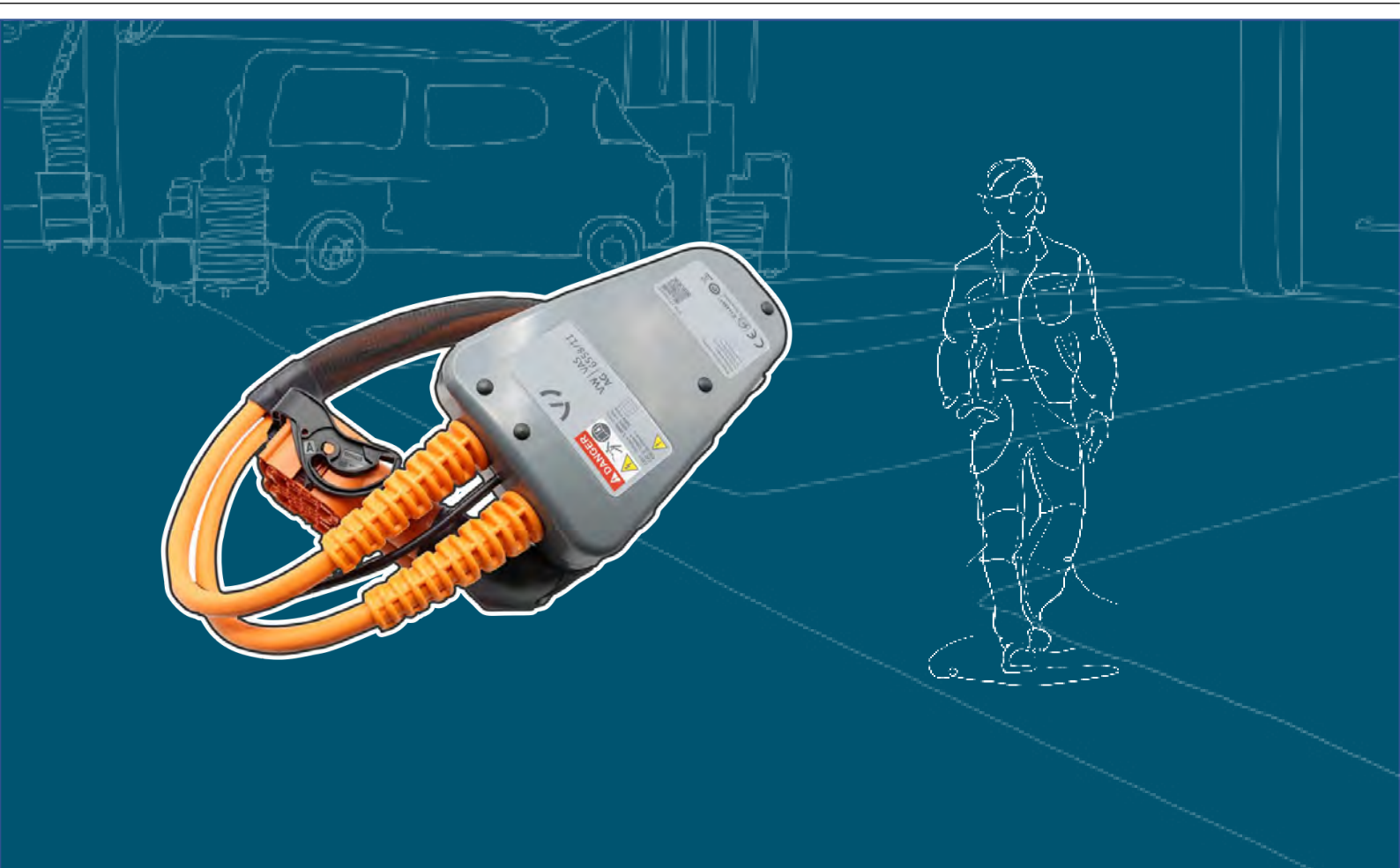

## Operating manual

High-voltage test adapter VAS 6558/11



Revision	Date	Reason
V00	02.04.2020	First edition
V01	15.07.2020	Complete revision
V02	15.10.2020	Revision after certification
V03	15.12.2020	Addition of cMETus registration number
V04	21.03.2022	Transfer to Stodia
V05	18.01.2024	Updating of certificate: China RoHS

## Legal notice

### Manufacturer

STODIA GmbH  
 Battery & Diagnostics Technology  
 Im Freitagsmoor 45  
 38518 Gifhorn, Germany  
 Phone: +49 (0) 5371 / 945 93 96-0  
 info@stodia.de  
 www.stodia.de

### Reproduction

Reproduction or reprinting, whether in whole or in part, always requires the written permission of the manufacturer.

### Copyright

TRANSLATION OF THE ORIGINAL OPERATING MANUAL

All rights reserved.

All text, images and graphics are subject to copyright and other intellectual property laws.

Copyright 2024 STODIA GmbH.

### Image sources

Symbols for warnings, prohibitions, mandatory actions and standards are taken from publicly accessible sources, such as the Internet. CAD product images and product photos are provided by the manufacturer. Images showing the product in use are provided with a reference to the source.

# Contents

<b>LEGAL NOTICE</b>	<b>2</b>
<b>CONTENTS</b>	<b>3</b>
<b>INTRODUCTION</b>	<b>4</b>
Preliminary information	4
Validity of the declaration of conformity	4
Manufacturer specifications	4
<b>SAFETY</b>	<b>5</b>
Warning levels	5
Important safety instructions	5
Intended use	6
Requirements for the target group	7
Duties of the operator	7
<b>PRODUCT DESCRIPTION</b>	<b>8</b>
Scope of delivery	8
Design	8
Symbols and connections	9
Wiring diagram	10
Technical data	11
<b>OPERATION</b>	<b>12</b>
Startup	12
Cleaning	14
Storage	14
Disposal	14
Maintenance	14
<b>HELP</b>	<b>15</b>
Warranty	15
Customer service	15

## Preliminary information

Read through this operating manual carefully before using the product.

The product is delivered with a USB stick containing the operating manual in various languages. You can find the current version and additional languages on our homepage.



There is a QR code on the product. You can scan this QR code with a device that is connected to the internet to go directly to the download area for your product.

The operating manual is an essential part of the product and must be kept together with the product. If you sell or transfer ownership of the product, the operating manual must be handed over to the new operator.

In addition to this operating manual, you must observe all relevant regulations for diagnostics or fault finding of intrinsically safe high-voltage systems in road vehicles. This includes but is not limited to: instructions for the vehicle manufacturer's diagnostics systems, company-specific safety requirements and the state of the art for working with high-voltage systems.

## Validity of the declaration of conformity

The declaration of conformity applies to the product described in the operating manual. Any changes, modifications or extensions shall void the declaration of conformity and the risk assessment.

## Manufacturer specifications

Since its founding, our company has focused on groundbreaking solutions for electromobility. STODIA GmbH develops and produces custom solutions for the automotive industry, the energy storage sector, repair shops and special vehicle fleets.

Our core products are innovative energy storage systems, both stationary and mobile, which are essential technologies for advancing the energy revolution and energy autonomy. STODIA's portfolio also includes smart charging and battery technology, diagnostic systems, battery and cell management, and vehicle-wide measurement and diagnostic technology.

With experience in both software and hardware development, STODIA GmbH is your dependable partner at every production stage, from prototyping to series production.

This operating manual is only valid for the following product:

Item number      22100440  
Designation      High-voltage test adapter VAS 6558/11

## Warning levels

This chapter provides information about the warning levels used in this operating manual.

### **DANGER**

Failure to observe the safety instructions **WILL** result in death or serious injury!

### **WARNING**

Failure to observe with the safety instructions **CAN** result in death or serious injury!

### **CAUTION**

Failure to observe the safety instructions **CAN** result in minor physical injury!

## Important safety instructions

This chapter contains the safety instructions that must be observed when handling the product.



### **WARNING**

#### **Danger of fatal electric shock!**

The electrical voltage in other systems is lethal and can cause death by electric shock!

- Do not use the product for measurements on utility power circuits!



### WARNING

#### Danger of fatal electric shock!

The electrical voltage in high-voltage systems is lethal and can cause death by electric shock!

Liquids, condensation and high humidity can cause short circuits!

- Do not let the product come into contact with liquids!
- Use the product only in dry and enclosed spaces!



### WARNING

#### Danger of fatal electric shock!

The electrical voltage in the product is dangerous and can cause serious injury or death from electric shock!

Defective and damaged products cannot guarantee protection against electrical voltage!

- Do not let the product come into contact with chemicals!
- Replace a defective or damaged product immediately!
- Never attempt to repair or tamper with the product!

## Intended use

Use the product only in accordance with this operating manual; otherwise the electrical hazard protection provided by the product can no longer be guaranteed.

The product is used to adapt the VAS 6558/VAS 6558A high-voltage measurement module to the vehicle-side plug connection specified by the vehicle manufacturer in the guided fault finding.

The product may only be used on high-voltage systems that have been certifiably de-energized.

The product must not be used to test that the circuit is de-energized.

The product is suitable for the following measurements:

- Insulation resistance measurement
- Continuity measurement

In this operating manual, vehicle manufacturers are exclusively defined as vehicle manufacturers in the Volkswagen Group.

Any use beyond what is listed here is prohibited.

## Requirements for the target group

Only qualified personnel may work with this product!

In this operating manual, qualified personnel is defined as personnel meeting all requirements for working on high-voltage systems applicable in the country of operation, as defined by:

- Regulations applicable in the country of operation
- Qualification according to DGUV 200-005 level 2 or higher, or equivalent
- Specifications from the vehicle manufacturer and/or the operator.

At all times while using the product, staff must wear the personal protective equipment prescribed by the vehicle manufacturer for work on high-voltage systems.

## Duties of the operator

The operator is responsible for ensuring that all staff working with the measurement adapter fulfills the requirements for the target group.

The operator is also responsible for ensuring that the following conditions are met:

- The measurement adapter is always in perfect working order.
- The regular inspection intervals for the measurement adapter are observed and recorded.

## Scope of delivery

Immediately check the condition of the product and the completeness of the delivery. If anything is missing or defective, please contact the manufacturer immediately.



- (1) High-voltage test adapter
- (2) USB stick with operating manual

## Design

Product design:

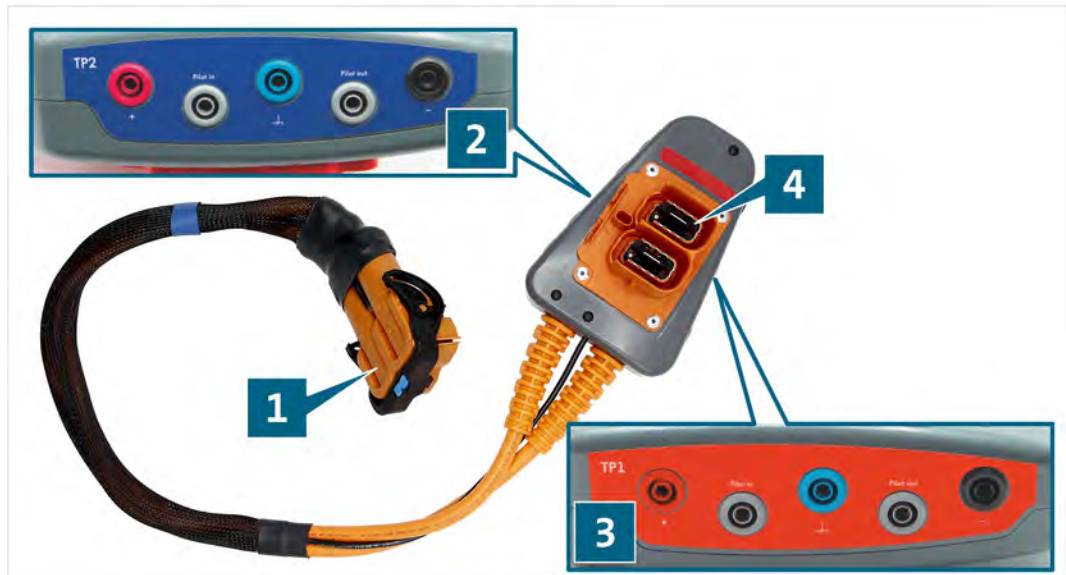











- (1) Socket
- (2) TP2 test sockets (see wiring diagram)
- (3) TP1 test sockets (see wiring diagram)
- (4) Plug



## Symbols and connections

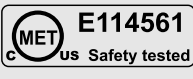

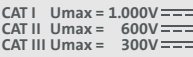





The following symbols are shown on the product:

Symbol	Meaning
	General warning symbols
	Electrical hazard! Read the operating manual!
	The serial number is used in conjunction with the manufacturer part number to identify the product.
	The manufacturer part number is used in conjunction with the serial number to identify the product.
	The product complies with protection class II, meaning it has increased or double insulation between active and accessible parts in accordance with VDE 0100, Part 410/412.1.
	The disposal instructions prohibit disposal of the product with household waste. Always dispose of the product in accordance with all local disposal regulations.
	The CE marking certifies that the product complies with all applicable European regulations and has been subjected to the prescribed conformity assessment procedure.
	This label certifies that the product complies with the limits of GB/T 26572-2011 ("China-ROHS").
	The cMETus mark indicates that the product has been tested and certified by an NRTL in accordance with applicable standards. The manufacturer is listed under the number E114561 at the Eurofins testing labs.
	The test seal identifies the product as having been approved for use in workshops and production facilities belonging to the vehicle manufacturer.
	Indicates which measurement categories the product is intended for according to IEC 61010-31. The rated voltage is based on the measurement category.

The product has the following connection areas:

- TP1
- TP2

Each connection area has the following test sockets:

Connector	Function
 	Ground socket
 	Positive socket
 	Negative socket
 Pilot in	Pilot socket
 Pilot out	

## Wiring diagram

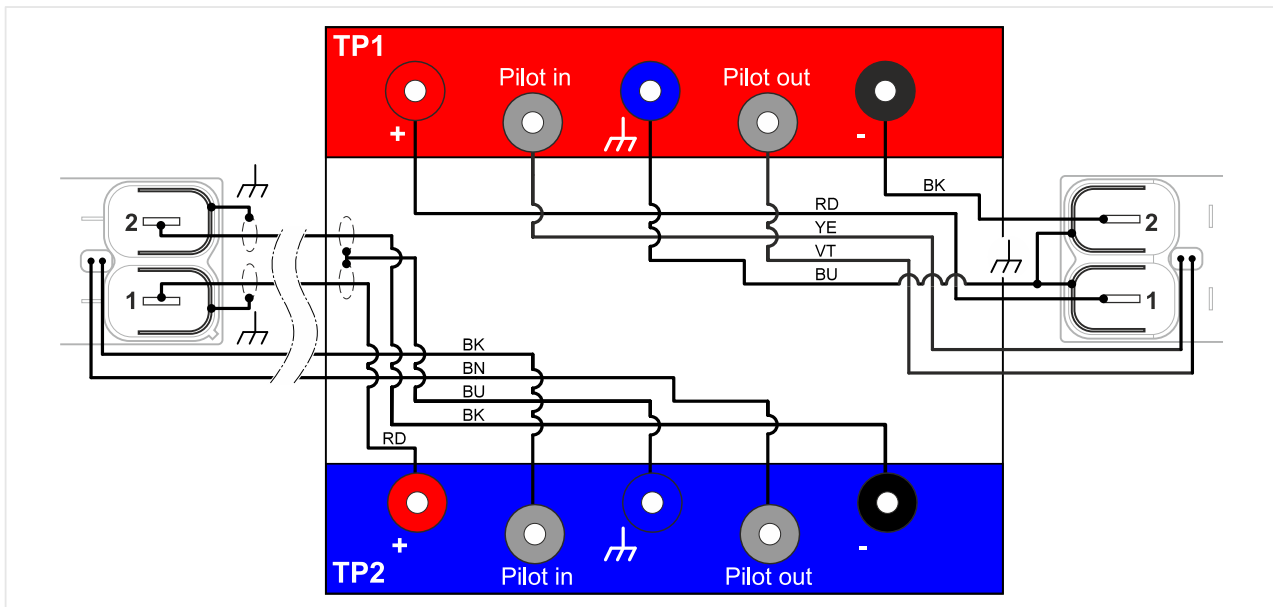

## Technical data

Rated data	Values
Manufacturer number	22100440
Maximum rated voltage	CAT I: DC 1000 V CAT II: DC 600 V CAT III: DC 300 V
Maximum rated current	≤ DC 60 V: 1000 mA > DC 60 V: 2 mA
Protection class	II / double insulated
Weight	~ 1550 g
Dimensions L/H/W	~ 190 mm/130 mm/100 mm
Cable length	~ 800 mm

Ambient conditions	Operation	Storage	Transportation
Temperature	5 °C to 40 °C	-20 °C to 60 °C	-20 °C to 60 °C
Elevation above sea level	max. 2000 m	No limitation.	
Humidity	Max. 80% up to 31°C, decreasing linearly to 50% at 40°C	Max. 85%	
Pollution rating	2		
Condensation	Not permitted. Maximum permissible relative humidity: 60% in environments with corrosive gas/air.		

This section provides information about the following activities:

- Startup
- Cleaning
- Storage
- Disposal
- Maintenance

## Startup



### **DANGER**

#### **Danger of fatal electric shock!**

The electrical voltage in high-voltage systems is lethal and will cause death by electric shock!

- Use the product only on high-voltage systems and components that have been certifiably de-energized!



### **WARNING**

#### **Danger of fatal electric shock!**

The electrical voltage in high-voltage systems is lethal and can cause death by electric shock!

- Use the product only for the applications intended by the vehicle manufacturer!

1. Follow the safety instructions.



2. Connect the plug to the disconnected socket of the connection you want to test.
3. Lock this connection.
4. Connect the socket to the plug on the high-voltage battery.
5. Lock this connection.

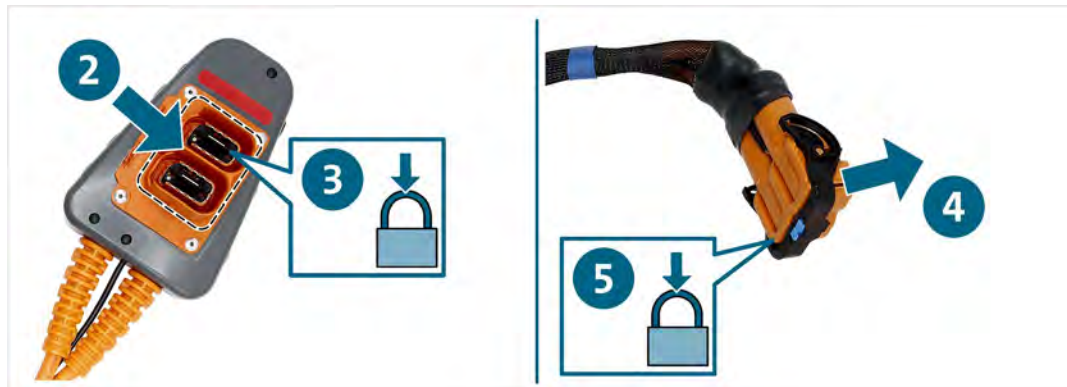

6. Connect the high-voltage measurement module to the high-voltage test adapter according to the guided fault finding.



- ✓ You can now perform measurements in accordance with the guided fault finding.

## Cleaning



### **DANGER**

#### **Danger of fatal electric shock!**

The electrical voltage in high-voltage systems is lethal and will cause death by electric shock!

- Disconnect the product from all power sources before cleaning the product!

Observe the safety instructions!

Use only a dry cloth to clean the product.

## Storage

Store the product in a dry and dust-free location when not in use.

## Disposal

Observe the safety instructions!

Always dispose of the product in accordance with all local disposal regulations.

## Maintenance

Observe the safety instructions!

National and local requirements for regular testing must be observed!

Test the product for proper function at intervals of no more than 24 months.

Contact the manufacturer to have a professional function test performed.

## Warranty

STODIA GmbH grants a warranty period of 24 months from the date of purchase. The warranty is valid for demonstrable defects in functional material and workmanship.

Further information on the warranty conditions can be found in the terms and conditions on the manufacturer's website.

## Customer service

Always include the item number and, if available, the serial number with any product queries. Both numbers are found on the product.

STODIA GmbH  
Battery and Diagnostics Technology  
Im Freitagsmoor 45  
38518 Gifhorn, Germany

Phone: +49 (0) 5371 / 945 93 96-0

[service@stodia.de](mailto:service@stodia.de)

[www.stodia.de](http://www.stodia.de)

Volkswagen Aktiengesellschaft  
K-GVO-LW  
Group After Sales – Group Service  
Literature and Systems  
Repair Shop Equipment  
PO box 011/4915  
38442 Wolfsburg, Germany

For internal use only  
Subject to technical changes  
Version 01/2024