

VOLKSWAGEN

AKTIENGESELLSCHAFT



Operating manual

High-voltage test adapter VAS 6558A/30



| Revision | Date | Reason |
|----------|------------|--|
| V00 | 13.07.2018 | First edition |
| V01 | 04.03.2019 | DOC ID added |
| V02 | 25.08.2020 | Complete revision |
| V03 | 28.04.2022 | Transfer to Stodia |
| V04 | 27.06.2022 | Adjustments from TÜV report |
| V05 | 24.01.2024 | Updating of certificates: China RoHS, UL |

Legal notice

Manufacturer

STODIA GmbH
 Battery & Diagnostics Technology
 Im Freitagsmoor 45
 38518 Gifhorn, Germany
 Phone: +49 (0) 5371 / 945 93 96-0
 info@stodia.de
 www.stodia.de

Reproduction

Reproduction or reprinting, whether in whole or in part, always requires the written permission of the manufacturer.

Copyright

TRANSLATION OF THE ORIGINAL OPERATING MANUAL

All rights reserved.

All text, images and graphics are subject to copyright and other intellectual property laws.

Copyright 2024 STODIA GmbH.

Image sources

Symbols for warnings, prohibitions, mandatory actions and standards are taken from publicly accessible sources, such as the Internet. CAD product images and product photos are provided by the manufacturer. Images showing the product in use are provided with a reference to the source.

Contents

| | |
|---|-----------|
| LEGAL NOTICE | 2 |
| CONTENTS | 3 |
| INTRODUCTION | 4 |
| Preliminary information | 4 |
| Validity of the declaration of conformity | 4 |
| Manufacturer specifications | 4 |
| SAFETY | 5 |
| Warning levels | 5 |
| Important safety instructions | 5 |
| Intended use | 6 |
| Requirements for the target group | 6 |
| Duties of the operator | 6 |
| PRODUCT DESCRIPTION | 7 |
| Scope of delivery | 7 |
| Design | 7 |
| Symbols and connections | 8 |
| Wiring diagram | 9 |
| Technical data | 10 |
| OPERATION | 11 |
| Startup | 11 |
| Detaching the plug connections | 12 |
| Cleaning | 13 |
| Storage and transportation | 13 |
| Disposal | 13 |
| Maintenance | 13 |
| HELP | 14 |
| Warranty | 14 |
| Customer service | 14 |

Preliminary information

Read through this operating manual carefully before using the product.

The product is delivered with a USB stick containing the operating manual in various languages. You can find the current version and additional languages on our homepage.

The operating manual is an essential part of the product and must be kept together with the product. If you sell or transfer ownership of the product, the operating manual must be handed over to the new operator.

In addition to this operating manual, you must observe all relevant regulations for diagnostics or fault finding of intrinsically safe high-voltage systems in road vehicles. This includes but is not limited to: instructions for the vehicle manufacturer's diagnostics systems, company-specific safety requirements and the state of the art for working with high-voltage systems.

Validity of the declaration of conformity

The declaration of conformity applies to the product described in the operating manual. Any changes, modifications or extensions shall void the declaration of conformity and the risk assessment.

Manufacturer specifications

Since its founding, our company has focused on groundbreaking solutions for electromobility. STODIA GmbH develops and produces custom solutions for the automotive industry, the energy storage sector, repair shops and special vehicle fleets.

Our core products are innovative energy storage systems, both stationary and mobile, which are essential technologies for advancing the energy revolution and energy autonomy. STODIA's portfolio also includes smart charging and battery technology, diagnostic systems, battery and cell management, and vehicle-wide measurement and diagnostic technology.

With experience in both software and hardware development, STODIA GmbH is your dependable partner at every production stage, from prototyping to series production.

This operating manual is only valid for the following product:

Item number 22101847

Designation High-voltage test adapter VAS 6558A/30

Warning levels

This chapter provides information about the warning levels used in this operating manual.

DANGER

Failure to observe the safety instructions **WILL** result in death or serious injury!

WARNING

Failure to observe with the safety instructions **CAN** result in death or serious injury!

CAUTION

Failure to observe the safety instructions **CAN** result in minor physical injury!

Important safety instructions

This chapter contains the safety instructions that must be observed when handling the product.



DANGER

Danger of fatal electric shock

The electrical voltage in other systems is lethal and will cause death by electric shock.

- Do not use the product for measurements on utility power circuits!
- Never attempt to power other devices with the product!



WARNING

Danger of fatal electric shock

The electrical voltage in high-voltage systems is lethal and can cause death by electric shock.

Liquids, condensation and high humidity can cause short circuits!

- Do not let the product come into contact with liquids!
- Use the product only in dry and enclosed spaces!



WARNING

Danger of fatal electric shock

The electrical voltage in the product is dangerous and can cause serious injury or death from electric shock.

Defective and damaged products cannot guarantee protection against electrical voltage.

- Do not let the product come into contact with chemicals!
- Replace a defective or damaged product immediately!
- Never attempt to repair or tamper with the product!

Intended use

Use the product only in accordance with this operating manual; otherwise the electrical hazard protection provided by the product can no longer be guaranteed.

The product is used to adapt the VAS 6558/VAS 6558A high-voltage measurement module to the vehicle-side plug connection specified by the vehicle manufacturer in the guided fault finding.

The product is equipped with safety resistors and is suitable for the following measurements:

- Certified test for de-energized circuit according to the manufacturer's specifications
- Insulation resistance measurement (**only permitted with measuring device with max. DC 1000 V, 2 mA!**)
- Continuity measurement (**only permitted with measuring device with max. DC 60 V, 1 A!**)

Use only the plug connections on the vehicle that the manufacturer has specified in the guided fault finding.

In this operating manual, vehicle manufacturers are exclusively defined as vehicle manufacturers in the Volkswagen Group.

Any use beyond what is listed here is prohibited.

Requirements for the target group

Only qualified personnel may work with this product!

In this operating manual, qualified personnel is defined as personnel meeting all requirements for working on high-voltage systems applicable in the country of operation, as defined by:

- Regulations applicable in the country of operation
- Qualification according to DGUV 200-005 level 2 or higher, or equivalent
- Specifications from the vehicle manufacturer and/or the operator.

At all times while using the product, staff must wear the personal protective equipment prescribed by the vehicle manufacturer for work on high-voltage systems.

Duties of the operator

The operator is responsible for ensuring that all staff working with the test adapter fulfills the requirements for the target group.

Furthermore, the operator is responsible for ensuring the following:

- The test adapter is always in perfect working order.
- The regular inspection intervals for the test adapter are observed and recorded.

Scope of delivery

Immediately check the condition of the product and the completeness of the delivery. If anything is missing or defective, please contact the manufacturer immediately.



- (1) Carrying case
- (2) High-voltage test adapter
- (3) USB stick with operating manual

Design











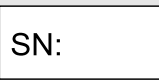

Product design:



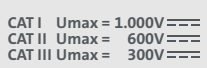

- (1) Plug
- (2) Test sockets (see wiring diagram)
- (3) Socket

Symbols and connections

The following symbols are shown on the product:

| Symbol | Meaning |
|---|---|
|  | General warning symbols |
|  | Electrical hazard! Read the operating manual! |
|  | The serial number is used in conjunction with the manufacturer part number to identify the product. |
|  | The manufacturer part number is used in conjunction with the serial number to identify the product. |
|  | The product complies with protection class II, meaning it has increased or double insulation between active and accessible parts in accordance with VDE 0100, Part 410/412.1. |
|  | The disposal instructions prohibit disposal of the product with household waste. Always dispose of the product in accordance with all local disposal regulations. |
|  | The CE marking certifies that the product complies with all applicable European regulations and has been subjected to the prescribed conformity assessment procedure. |
|  | This label certifies that the product complies with the limits of GB/T 26572-2011 ("China-ROHS"). |
|  | The cTÜVus mark indicates that the product has been tested and certified by an NRTL in accordance with applicable standards. |
|  | The test seal identifies the product as having been approved for use in workshops and production facilities belonging to the vehicle manufacturer. |
|  | Indicates which measurement categories the product is intended for according to IEC 61010-31. The rated voltage is based on the measurement category. |
|  | QR code for accessing the product documentation on mobile devices. |

The product has the following sockets:

| Connector | Function |
|---|-----------------|
|  | Ground socket |
|  | Positive socket |
|  | Negative socket |

Wiring diagram

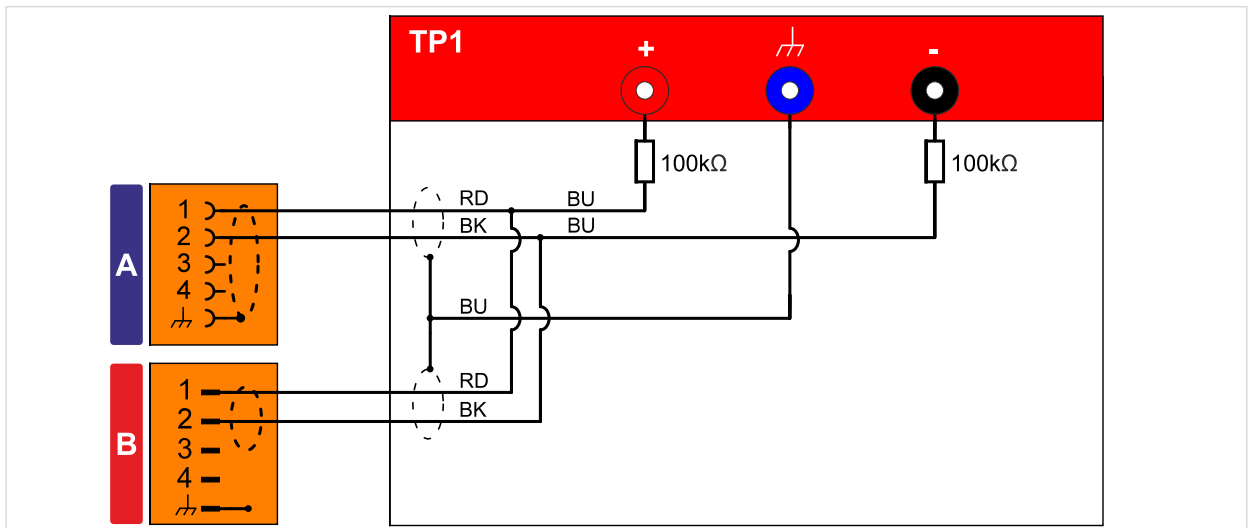

Technical data

| Rated data | Values |
|-----------------------|---|
| Manufacturer number | 22101847 |
| Maximum rated voltage | CAT I: DC 1000 V CAT II: DC 600 V CAT III: DC 300 V |
| Maximum rated current | ≤ DC 60 V: 1000 mA > DC 60 V: 2 mA |
| Protection class | II / double insulated |
| Weight | ~ 1000 g |
| Dimensions L/H/W | ~ 180 mm/120 mm/55 mm |
| Cable length | 890 mm |

| Ambient conditions | Operation | Storage | Transportation |
|---------------------------|---|----------------|----------------|
| Temperature | 0°C to 50°C | -20°C to 60°C | -20°C to 60°C |
| Elevation above sea level | Max. 2000 m | No limitation. | |
| Humidity | Max. 80% up to 31°C, decreasing linearly to 50% at 40°C | Max. 85% | |
| Pollution rating | 2 | | |
| Condensation | Not permitted. Maximum permissible relative humidity: 60% in environments with corrosive gas/air. | | |

Startup



WARNING

Danger of fatal electric shock

The electrical voltage in high-voltage systems is lethal and can cause death by electric shock.

- Use the product only for the applications intended by the vehicle manufacturer!



CAUTION

Risk of damage!

Plug connections lock into place when attached.

- Unlock the plug connections before detaching them! (see the chapter “Detaching the plug connections”)

1. Follow the safety instructions.



2. Connect the plug to the disconnected socket of the connection you want to test.
3. Lock the connection.
4. Connect the socket to the disconnected plug of the connection you want to test.
5. Lock the connection.
6. Connect the high-voltage measurement module to the high-voltage test adapter according to the guided fault finding.

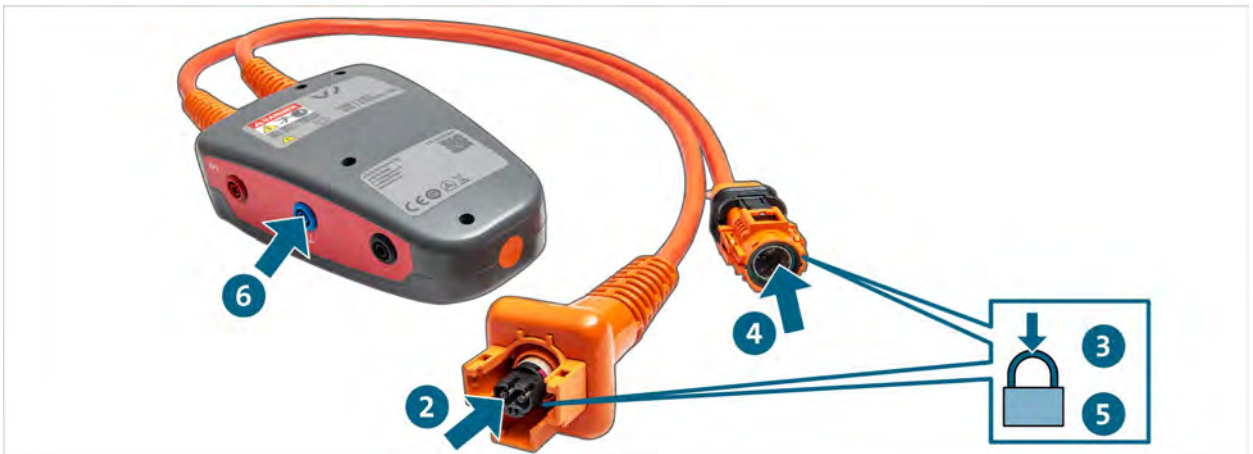

- ✓ You can now perform measurements in accordance with the guided fault finding.

Detaching the plug connections

The plug connections have an automatic locking mechanism. To detach a plug connection:

1. Push in and hold the tongue (blue).
2. Pull the retaining clip out.
3. Push in and hold the tongue (orange).
4. Pull the plug connection apart.

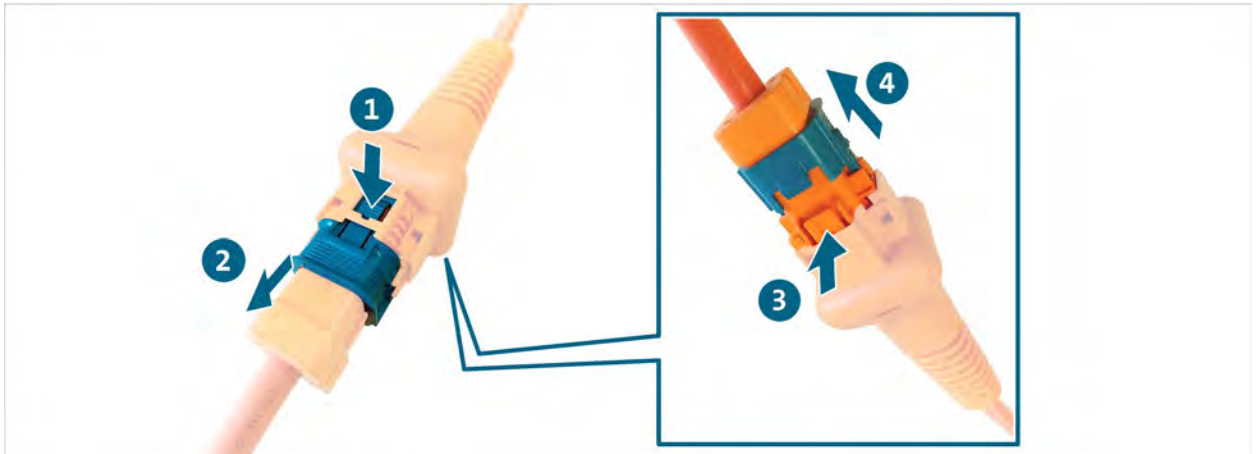

- ✓ The plug connection is now detached.

Cleaning



DANGER

Danger of fatal electric shock

The electrical voltage in high-voltage systems is lethal and will cause death by electric shock.

- Disconnect the product from all power sources before cleaning the product!

Observe the safety instructions!

Use only a dry cloth to clean the product.

Storage and transportation

Store and transport the product only in the carrying case (see the “Scope of delivery” section).

Disposal

Observe the safety instructions!

Always dispose of the product in accordance with all local disposal regulations.

Maintenance

Observe the safety instructions!

National and local requirements for regular testing must be observed!

Test the product for proper function at intervals of no more than 24 months.

Contact the manufacturer to have a professional function test performed.

Warranty

STODIA GmbH grants a warranty period of 24 months from the date of purchase. The warranty is valid for demonstrable defects in functional material and workmanship.

Further information on the warranty conditions can be found in the terms and conditions on the manufacturer's website.

Customer service

Always include the item number and, if available, the serial number with any product queries. Both numbers are found on the product.

STODIA GmbH

Battery and Diagnostics Technology

Im Freitagsmoor 45

38518 Gifhorn, Germany

Phone: +49 (0) 5371 / 945 93 96-0

service@stodia.de

www.stodia.de

Volkswagen Aktiengesellschaft
K-GVO-LW
Group After Sales – Group Service
Literature and Systems
Repair Shop Equipment
PO box 011/4915
38442 Wolfsburg, Germany

For internal use only
Subject to technical changes
Version 01/2024