

Operating manual

High-voltage test and self-test adapters CHAdeMO

11.ST.2210.2667_BA_V00_EN

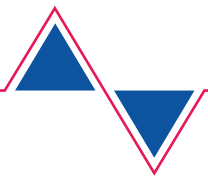

Version	Date	Reason
V00	13.09.2023	First edition

Legal notice

Legal notice

Manufacturer STODIA GmbH
Battery & Diagnostics Technology
Im Freitagsmoor 45
38518 Gifhorn, Germany
Phone: +49 (0) 5371 / 945 93 96-0
info@stodia.de
www.stodia.de

Reproduction Reproduction or reprinting, whether in whole or in part, always requires the written permission of the manufacturer.

Copyright TRANSLATION OF THE ORIGINAL OPERATING MANUAL
All rights reserved.
All text, images and graphics are subject to copyright and other intellectual property laws.
Copyright 2023 STODIA GmbH.

Image sources Symbols for warnings, prohibitions, mandatory actions and standards are taken from publicly accessible sources, such as the Internet. CAD product images and product photos are provided by the manufacturer. Images showing the product in use are provided with a reference to the source.

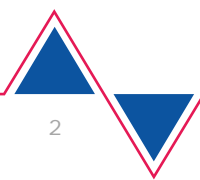

Contents

Contents	3
1 Introduction.....	4
1.1 Preliminary information.....	4
1.2 Validity of the declaration of conformity	4
1.3 Manufacturer specifications	4
2 Safety.....	5
2.1 Warning levels.....	5
2.2 Important safety instructions.....	5
2.3 Intended use	6
2.4 Requirements for the target group.....	6
2.5 Duties of the operator	6
3 Product description.....	7
3.1 Scope of delivery.....	7
3.2 Design	8
3.2.1 Self-test adapter design:	8
3.2.2 High-voltage test adapter design:	8
3.3 Symbols and connections.....	9
3.3.1 Warning sign	9
3.3.2 Nameplates	10
3.4 Wiring diagram	11
3.5 Technical data	11
3.5.1 High-voltage test adapter.....	11
3.5.2 Self-test adapter.....	12
3.5.3 Ambient conditions.....	12
4 Operation.....	13
4.1 Startup.....	13
4.1.1 Testing the high-voltage test adapter	14
4.1.2 Performing measurements.....	15
4.2 Cleaning	15
4.3 Storage	15
4.4 Disposal	15
4.5 Maintenance.....	16
4.5.1 Replacing fuses	16
5 Help.....	17
5.1 Warranty.....	17
5.2 Customer service	17

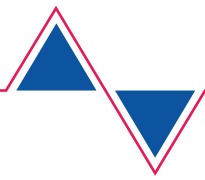

1 Introduction

1.1 Preliminary information

Read through this operating manual carefully before using the product.

The product is delivered with a USB stick containing the operating manual in various languages. You can find the current version and additional languages on our homepage.

The operating manual is an essential part of the product and must be kept together with the product. If you sell or transfer ownership of the product, the operating manual must be handed over to the new operator.

In addition to this operating manual, you must observe all relevant regulations for diagnostics or fault finding of intrinsically safe high-voltage systems in road vehicles. This includes but is not limited to: instructions for the vehicle manufacturer's diagnostics systems, company-specific safety requirements and the state of the art for working with high-voltage systems.

1.2 Validity of the declaration of conformity

The declaration of conformity applies to the product described in the operating manual. Any changes, modifications or extensions shall void the declaration of conformity and the risk assessment.

1.3 Manufacturer specifications

Since its founding, our company has focused on groundbreaking solutions for electromobility. STODIA GmbH develops and produces custom solutions for the automotive industry, the energy storage sector, repair shops and special vehicle fleets.

Our core products are innovative energy storage systems, both stationary and mobile, which are essential technologies for advancing the energy revolution and energy autonomy. STODIA's portfolio also includes smart charging and battery technology, diagnostic systems, battery and cell management, and vehicle-wide measurement and diagnostic technology.

With experience in both software and hardware development, STODIA GmbH is your dependable partner at every production stage, from prototyping to series production.

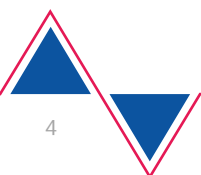

2 Safety

This operating manual is only valid for the following product:

Item number 22102061 + 22102663

Designation High-voltage test and self-test adapters CHAdeMO

2.1 Warning levels

This chapter provides information about the warning levels used in this operating manual.

DANGER

Failure to observe the safety instructions WILL result in death or serious injury!

WARNING

Failure to observe with the safety instructions CAN result in death or serious injury!

CAUTION

Failure to observe the safety instructions CAN result in minor physical injury!

2.2 Important safety instructions

This chapter contains the safety instructions that must be observed when handling the product.



DANGER

Danger of fatal electric shock

The electrical voltage in other systems is lethal and will cause death by electric shock.

- Do not use the product for measurements on utility power circuits!
- Never attempt to power other devices with the product!



WARNING

Danger of fatal electric shock

The electrical voltage in high-voltage systems is lethal and can cause death by electric shock.

Liquids, condensation and high humidity can cause short circuits!

- Do not let the product come into contact with liquids!
- Use the product only in dry and enclosed spaces!

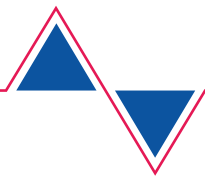

WARNING

Danger of fatal electric shock

Defective and damaged products can no longer guarantee protection against electrical voltage.

- Do not let the product come into contact with chemicals!
- Replace a defective or damaged product immediately!
- Never attempt to repair or tamper with the product!

2.3 Intended use

Use the product only in accordance with this operating manual; otherwise the electrical hazard protection provided by the product can no longer be guaranteed.

The product is a set of high-voltage measurement adapters for measuring high-voltage systems in electric vehicles at the on-board plug connection specified by the vehicle manufacturer.

The product is equipped with safety resistors and is suitable for the following measurements:

- Certified test for de-energized circuit according to the manufacturer's specifications
- Insulation resistance measurement
- Continuity measurement

The bridging adapter (item no. 22102663) supplied with the measuring adapter set may be used only for the purpose of testing the function of the high-voltage measurement adapter (item no. 22102061)!

In this operating manual, the term 'vehicle manufacturers' refers solely to vehicle manufacturers in the BMW Group.

Any use beyond what is listed here is prohibited.

2.4 Requirements for the target group

Only qualified personnel may work with this product!

In this operating manual, qualified personnel is defined as personnel meeting all requirements for working on high-voltage systems applicable in the country of operation, as defined by:

- Regulations applicable in the country of operation
- Qualification according to DGUV 200-005 level 2 or higher, or equivalent
- Specifications from the vehicle manufacturer and the operator (at least lightning protection class 3 with documented training).

At all times while using the product, staff must wear the personal protective equipment prescribed by the vehicle manufacturer for work on high-voltage systems.

2.5 Duties of the operator

The operator is responsible for ensuring that all staff working with the test adapter fulfills the requirements for the target group.

Furthermore, the operator is responsible for ensuring the following:

- The test adapter is always in perfect working order.
- The regular inspection intervals for the test adapter are observed and recorded.

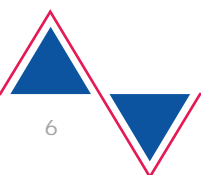

3 Product description

3.1 Scope of delivery

Test adapter and self-test adapter are available either in the set as shown here or with other adapters in a larger carrying case.

Immediately check the condition of the product and the completeness of the delivery. If anything is missing or defective, please contact the manufacturer immediately.



- (1) Carrying case
- (2) Self-test adapter (item no. 22102663)
- (3) High-voltage test adapter (item no. 22102061)
- (4) USB stick with operating manual

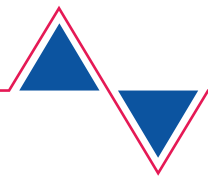

3.2 Design

3.2.1 Self-test adapter design:

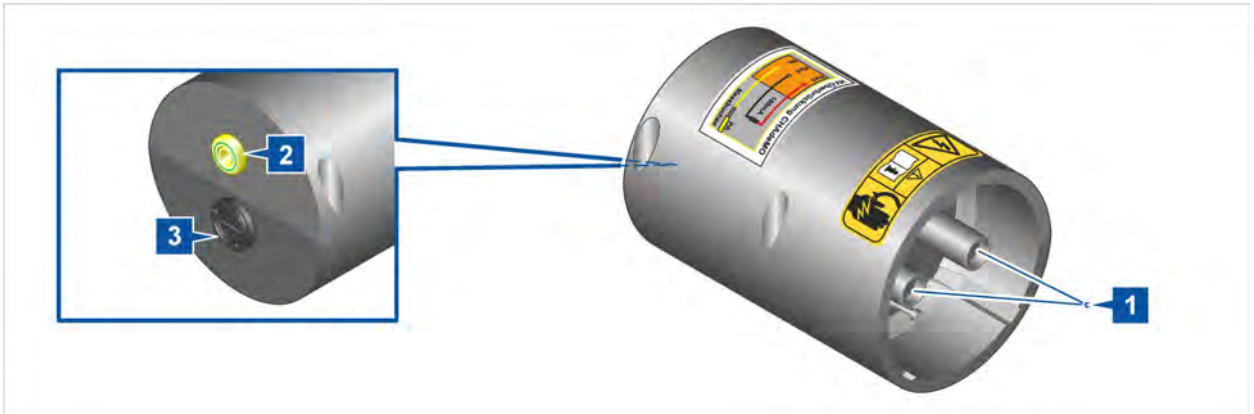

- (1) Contact sockets for CHAdeMO high-voltage test adapter
- (2) PE test socket
- (3) 0.1 A fuse, DC 1000 V, FF 6.3x32 mm

3.2.2 High-voltage test adapter design:

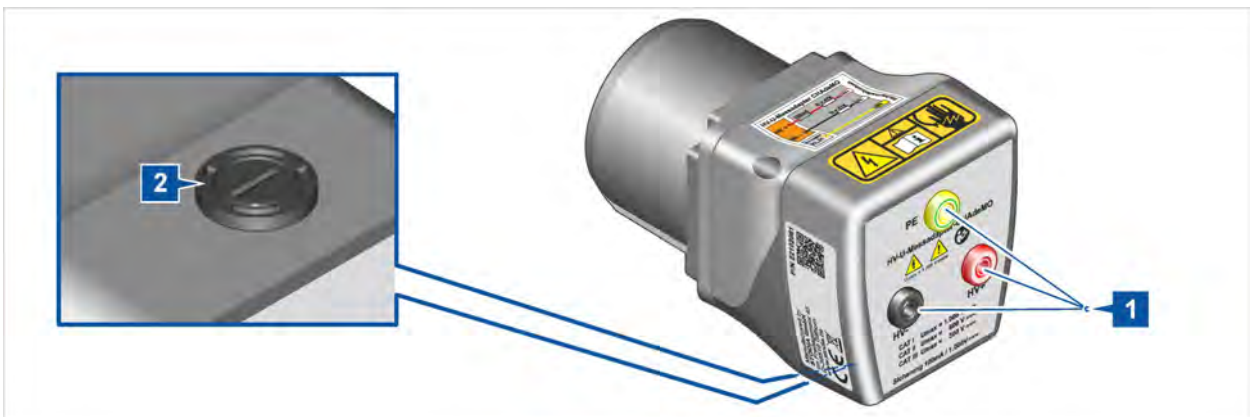

- (1) Test sockets (see wiring diagram)
- (2) 0.1 A fuse, DC 1000 V, FF 6.3x32 mm

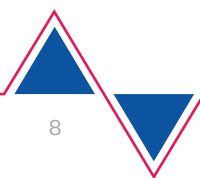

3.3 Symbols and connections

Stickers and nameplates are applied to the components included in the scope of delivery in the following positions:

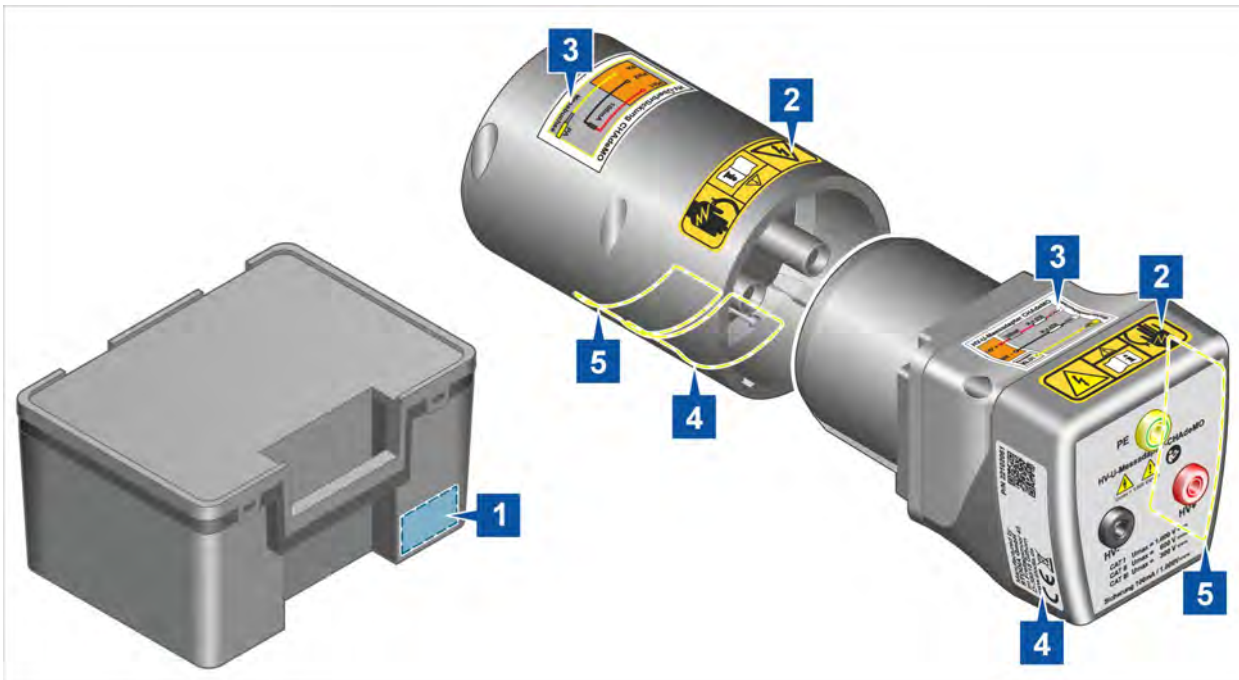

Item	Description
1	Carrying case nameplate
2	Warning of electrical hazard
3	Wiring diagrams
4	Nameplate for STODIA high-voltage measurement adapter
5	Nameplate for BMW high-voltage measurement adapter

3.3.1 Warning sign

Figure	Function
	<p>The sticker warns of the electrical danger of the high-voltage measuring adapter.</p>

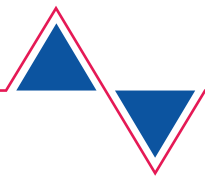

3.3.2 Nameplates

Figure	Function
	<p>The nameplates contain the following information:</p> <ul style="list-style-type: none"> • Manufacturer information • Manufacturer part number • Product type • Serial number • User requirements <p>You can use the serial number to track information relating to production.</p>

The following symbols and information are shown on the product stickers:

Symbol	Meaning
	Electrical hazard!
	General warning symbols
	This symbol warns of the risk of electric shock!
	Observe the operating manual!
SN:	The serial number is used in conjunction with the manufacturer part number to identify the product.
P/N	The manufacturer part number is used in conjunction with the serial number to identify the product.
	The disposal instructions prohibit disposal of the product with household waste. Always dispose of the product in accordance with all local disposal regulations.
CAT I U _{max} = 1.000V --- CAT II U _{max} = 600V --- CAT III U _{max} = 300V ---	This symbol indicates the measurement category for which the product may be used according to IEC 61010-31. The rated voltage is based on the measurement category.
	The CE marking certifies that the product complies with all applicable European regulations and has been subjected to the prescribed conformity assessment procedure.
	QR code for accessing the operating manual on mobile devices.

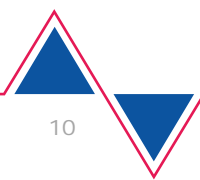

3.4 Wiring diagram

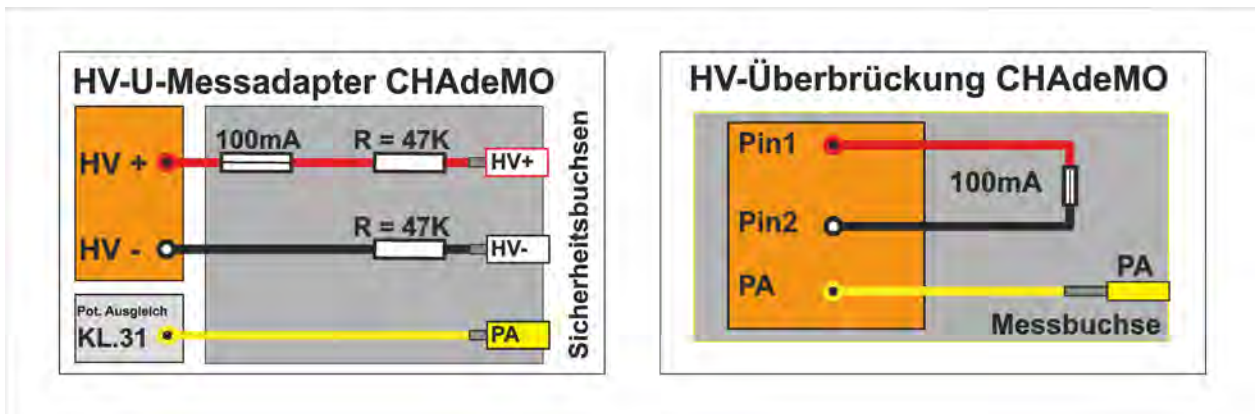

3.5 Technical data

3.5.1 High-voltage test adapter

Rated data	Values
Manufacturer number	22102061
Maximum rated voltage	CAT I: DC 1000 V CAT II: DC 600 V CAT III: DC 300 V
Maximum rated current	≤ DC 60 V: 1000 mA > DC 60 V: 2 mA
Fuse	0.1 A, DC 1000 V, FF 6.3x32 mm
Weight	~ 400 g
Dimensions L/H/W	138 mm/95 mm/86 mm

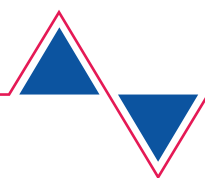

3.5.2 Self-test adapter

Rated data	Values
Manufacturer number	22102663
Maximum rated voltage	CAT I: DC 1000 V CAT II: DC 600 V CAT III: DC 300 V
Maximum rated current	≤ DC 60 V: 1000 mA > DC 60 V: 2 mA
Fuse	0.1 A, DC 1000 V, FF 6.3x32 mm
Weight	~ 230 g
Dimensions L/H/W	~123 mm/80 mm/80 mm

3.5.3 Ambient conditions

Ambient conditions	Operation	Storage	Transportation
Temperature	5°C to 40°C	-20°C to 60°C	-20°C to 60°C
Elevation above sea level	max. 2000 m	No limitation	
Humidity	Max. 80% up to 31°C, decreasing linearly to 50% at 40°C	Max. 85%	
Pollution rating	II		
	Condensation not permitted. Maximum permissible relative humidity: 60% in environments with corrosive gas/air.		

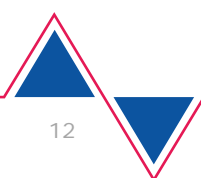

4 Operation

4.1 Startup



DANGER

Danger of fatal electric shock

The electrical voltage in high-voltage systems is lethal and will cause severe physical injury or death by electric shock.

Personal protection cannot be guaranteed if the high-voltage test adapter is faulty!

- Always carry out a self-test with a resistance measurement on the high-voltage test adapter before performing the certified test that the circuit is de-energized!



WARNING

Risk of explosion

Product components may produce sparks and electric arcs.

- Never disconnect high-voltage plug connections while under load!
- Do not use the product in potentially explosive atmospheres!
- Ensure that the product is at least 50 cm above the ground during operation!



WARNING

Danger of fatal electric shock

The electrical voltage in high-voltage systems is lethal and can cause death by electric shock.

- Use the product only for the applications intended by the vehicle manufacturer!

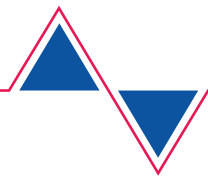

4.1.1 Testing the high-voltage test adapter

Before performing a certified test that the circuit is de-energized, you must check that the high-voltage test adapter is working correctly. To do so, you take a resistance measurement and continuity measurement using the self-test adapter.

1. Follow the safety instructions.



2. Connect the high-voltage test adapter to the self-test adapter.



3. First, take a resistance measurement at the “HV+” and “HV-” laboratory safety sockets.
 - ⇒ A resistance of 94 kOhm (10 kOhm tolerance) must be detected. If the detected resistance deviates from this level, there is a defect on the fuses or on the test adapter. If the resistance is too low (<80 kOhm), this indicates a short circuit.
4. Perform a continuity measurement on the laboratory safety sockets.
 - ✓ If all the measurements were successful, you can use the high-voltage test adapter for the certified test that the circuit is de-energized.
 - ✓ In the event of a defect, check the fuses first (see the chapter “Replacing fuses”).
 - ✓ If the defect persists, contact the manufacturer.

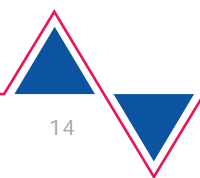

4.1.2 Performing measurements

1. Follow the safety instructions.
2. Connect the high-voltage test adapter to the CHAdeMO charging socket on the vehicle.
3. Connect a suitable measurement device (e.g. a multimeter or insulation resistance tester) to the test sockets on the high-voltage test adapter.



✓ You can now perform the measurements.

4.2 Cleaning



DANGER

Danger of fatal electric shock

The electrical voltage in high-voltage systems is lethal and will cause death by electric shock.

- Disconnect the product from all power sources before cleaning the product!

Observe the safety instructions!

Use only a dry cloth to clean the product.

4.3 Storage

Store and transport the product only in the carrying case (see the “Scope of delivery” section).

4.4 Disposal

Observe the safety instructions!

Always dispose of the product in accordance with all local disposal regulations.

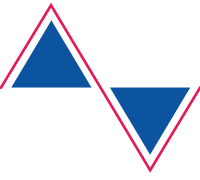

4.5 Maintenance

Observe the safety instructions!

National and local requirements for regular testing must be observed!

Test the product for proper function at intervals of no more than 24 months.

Contact the manufacturer to have a professional function test performed.

4.5.1 Replacing fuses



DANGER

Danger of fatal electric shock

The electrical voltage in the product is lethal and will cause death by electric shock!

- Disconnect the product from all plug connections before performing any maintenance work!

The high-voltage test adapter and self-test adapter are both fitted with a fuse (see the chapter “Design”). The following steps tell you how to replace a fuse.

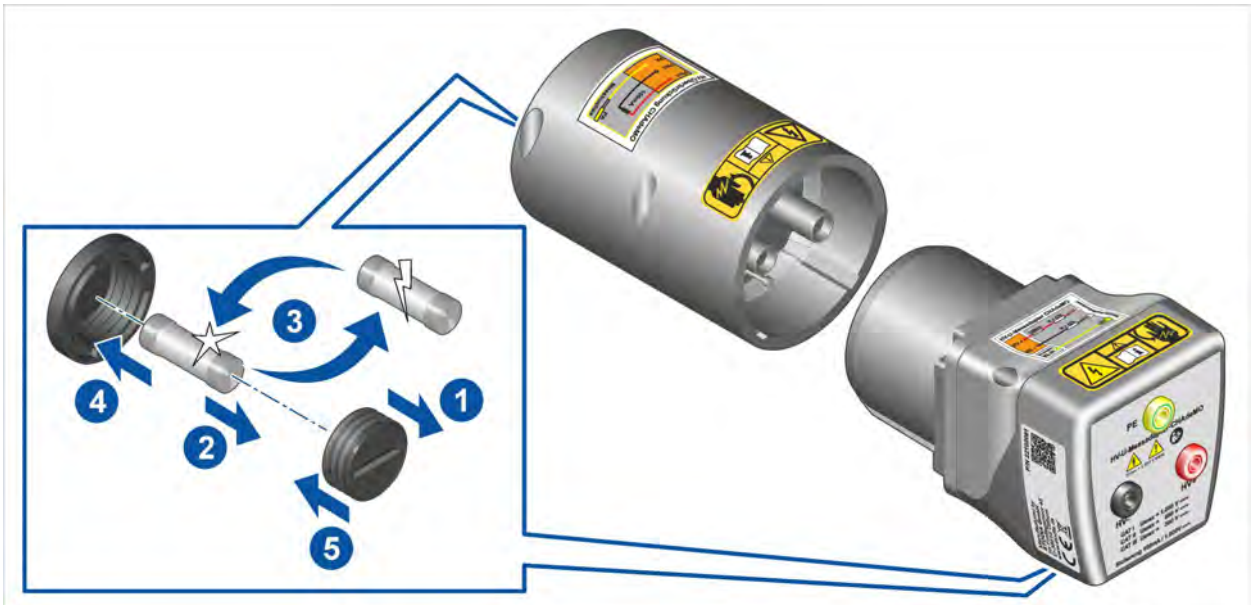

1. Open the fuse chamber.
 2. Remove the faulty fuse.
 3. Replace the faulty fuse with a new one of the same type (0.1 A, DC 1000 V/FF 6.3x32 mm).
 4. Insert the fuse into the fuse chamber.
 5. Screw the fuse chamber closed.
- ✓ You have replaced the fuse.

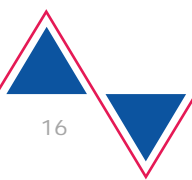

5 Help

5.1 Warranty

STODIA GmbH grants a warranty period of 24 months from the date of purchase. The warranty is valid for demonstrable defects in functional material and workmanship.

Further information on the warranty conditions can be found in the terms and conditions on the manufacturer's website.

5.2 Customer service

Always include the item number and, if available, the serial number with any product queries. Both numbers are found on the product.

STODIA GmbH
Battery and Diagnostics Technology
Im Freitagsmoor 45
38518 Gifhorn, Germany
Phone: +49 (0) 5371 / 945 93 96-0
service@stodia.de
www.stodia.de

STODIA GmbH
Battery & Diagnostics Technology

Im Freitagsmoor 45
38518 Gifhorn, Germany

Tel.: +49 (0) 53 71 / 945 93 96 – 0

info@stodia.de
www.stodia.de

Translation of the original operating manual.
Subject to technical changes.

 **STODIA**_{GMBH}
SPEICHER & DIAGNOSETECHNIK

