

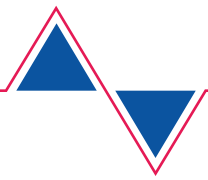

# Operating manual

Mobile high-voltage DC charger MDCC 22-500

41.EE.2210.3228\_BA\_V00\_EN



Revision	Date	Reason
V00	17.12.2021	First edition

## Legal notice

---

### Legal notice

**Manufacturer**

Stodia GmbH  
Battery & Diagnostics Technology  
Im Freitagsmoor 45  
38518 Gifhorn, Germany  
Phone: +49 (0) 5373 92197-0  
Fax: +49 (0) 5373 92197-88  
  
info@stodia.de  
www.stodia.de

**Reproduction**

Reproduction or reprinting, whether in whole or in part, always requires the written permission of the manufacturer.

**Copyright**

TRANSLATION OF THE ORIGINAL OPERATING MANUAL

All rights reserved.

All text, images and graphics are subject to copyright and other intellectual property laws.

Copyright 2021 Stodia GmbH.

**Image sources**

Symbols for warnings, prohibitions, mandatory actions and standards are taken from publicly accessible sources, such as the Internet. CAD product images and product photos are provided by the manufacturer. Images showing the product in use are provided with a reference to the source.

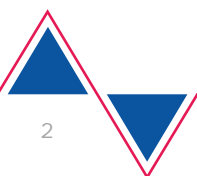

# Contents

---

<b>Contents .....</b>	<b>3</b>
<b>1 Introduction .....</b>	<b>6</b>
1.1 Preliminary information.....	6
1.2 Manufacturer specifications .....	6
<b>2 Safety .....</b>	<b>7</b>
2.1 Warning levels.....	7
2.2 Important safety instructions.....	8
2.3 Safety functions .....	9
2.3.1 Emergency stop button.....	9
2.4 Intended use .....	11
2.5 Requirements for the target group.....	12
2.6 Duties of the operator.....	12
2.7 Note to the grid operator .....	12
<b>3 Transport and storage .....</b>	<b>13</b>
3.1 Transport on receipt of goods.....	13
3.2 Unpacking the product .....	14
3.3 Transporting the product at the place of use.....	16
3.3.1 Engaging the parking brake.....	16
3.3.2 Adjusting the parking brake .....	17
3.4 Ambient conditions at the place of use .....	18
<b>4 Product description .....</b>	<b>19</b>
4.1 Scope of delivery .....	19
4.2 Design .....	20
4.3 Symbols and connections.....	21
4.4 Displays and controls.....	23
4.5 Technical data .....	24

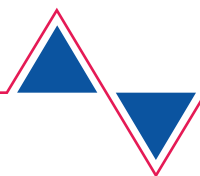

# Contents

---

<b>5</b>	<b>Operation .....</b>	<b>25</b>
5.1	Preparing the power supply connection .....	25
5.2	Startup.....	26
5.3	Initial startup.....	27
5.3.1	Cold start.....	27
5.3.2	Warm start .....	28
5.3.3	Setting the contrast.....	28
5.3.4	Startup after long downtimes .....	29
5.3.5	Self-test.....	29
5.4	Starting charging .....	30
5.4.1	Setting the charging time .....	30
5.4.2	Setting the auto-off function.....	30
5.4.3	Charging the vehicle .....	31
5.5	Finishing charging .....	32
5.5.1	Waiting for charging to finish .....	32
5.5.2	Canceling the charging process .....	32
5.5.3	Switching off the charger .....	33
5.6	Using the LC display.....	34
5.6.1	Function keys.....	34
5.6.2	Menu structure.....	35
5.6.3	Main menu .....	36
5.6.4	Operating parameters.....	36
5.6.5	Configuration parameters .....	37
5.6.6	Information parameters.....	38
5.6.7	Restoring the factory settings .....	40
5.7	Troubleshooting.....	41
5.7.1	Warning messages .....	41
5.8	Cleaning .....	43
5.9	Storage.....	43
5.10	Disposal .....	43

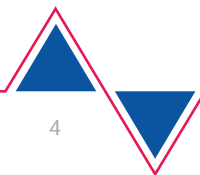

# Contents

---

<b>5.11</b>	<b>Maintenance .....</b>	<b>44</b>
5.11.1	Inspection and maintenance intervals .....	44
5.11.2	Authorized inspection and maintenance personnel.....	44
5.11.3	Inspection and maintenance areas on the product.....	45
5.11.4	Inspection and maintenance table .....	46
5.11.5	Tightening torques .....	48
5.11.6	Replacing wearing parts .....	48
<b>6</b>	<b>Help .....</b>	<b>52</b>
6.1	Warranty.....	52
6.2	Customer service .....	52

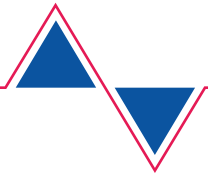

# 1 Introduction

---

## 1.1 Preliminary information

Read through this operating manual carefully before using the product.

The product is delivered with a USB stick containing the operating manual in various languages. You can find the current version and additional languages on our homepage.



There is a QR code on the product. You can scan this QR code with a device that is connected to the internet to go directly to the download area for your product.

The operating manual is an essential part of the product and must be kept together with the product. If you sell or transfer ownership of the product, the operating manual must be handed over to the new operator.

In addition to this operating manual, all the relevant regulations for charging traction batteries in electric vehicles are binding. They include but are not limited to: instructions from the vehicle manufacturer and the operator, company-specific safety requirements and the latest engineering standards for working with electric vehicles.

## 1.2 Manufacturer specifications

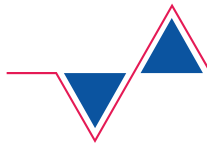

Since its founding, our company has focused on groundbreaking solutions for electromobility. Stodia GmbH develops and produces custom solutions for the automotive industry, the energy storage sector, repair shops and special vehicle fleets.

Our core products are innovative electrical storage systems, both stationary and mobile, which are essential technologies for advancing the energy revolution and energy autonomy. Stodia's portfolio also includes smart charging and battery technology, diagnostic systems, battery and cell management, and vehicle-wide measurement and diagnostic technology.

With experience in both software and hardware development, Stodia GmbH is your dependable partner at every production stage, from prototyping to series production.

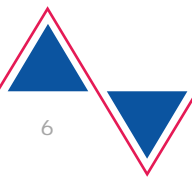

## 2 Safety

This safety chapter provides information about the following:

- The warning levels contained in this operating manual
- Safety functions
- Important safety instructions for the product
- Intended use of the product
- Requirements for the target group
- Duties of the operator
- Note to the grid operator

This operating manual is only valid for the following product:

Item number      22103228

Designation      Mobile high-voltageDC charger MDCC 22-500

### 2.1 Warning levels

This chapter provides information about the warning levels used in this operating manual.

#### **DANGER**

Failure to observe the safety instructions WILL result in death or serious injury!

#### **WARNING**

Failure to observe with the safety instructions CAN result in death or serious injury!

#### **CAUTION**

Failure to observe the safety instructions CAN result in minor physical injury!

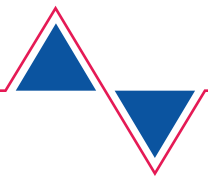

**CAUTION**

Failure to observe the safety instructions can lead to damage to the product!

## 2.2 Important safety instructions

This chapter contains the safety instructions that must be observed when handling the product.



**DANGER**

**Danger of fatal electric shock!**

The electrical voltage in the product is lethal and will cause death by electric shock!  
Liquids and moisture may cause short circuits!

- Do not let the product come into contact with liquids!
- Do not use the product outdoors or in damp environments!
- Protect the product against the effects of all kinds of weather!
- Do not attempt to open or damage the product!



**WARNING**

**Risk of explosion!**

Product components may produce sparks and electric arcs.

- Never disconnect high-voltage plug connections while under load!
- Do not use the product in potentially explosive atmospheres!
- Ensure that the product is at least 50 cm above the ground during operation!



**WARNING**

**Danger of electric shock!**

The electrical voltage in the product is dangerous and can cause serious injury from electric shock!

- Never attempt to power other devices with the product!

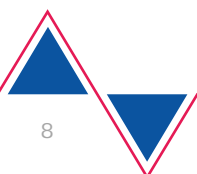



**WARNING****Danger of fatal electric shock!**

Defective and damaged products can no longer guarantee protection against electrical voltage!

- Do not let the product come into contact with chemicals!
- Replace a defective or damaged product immediately!
- Never attempt to repair or tamper with the product!

**CAUTION****Risk of damaging individual wires!**

When bending or coiling the DC charging cable, you can damage individual wires if the bending radius is too small.

- When coiling or laying the DC charging cable, maintain a bending radius of at least 22 cm!
- When coiling or laying the DC charging cable, maintain sufficient distance from the corners of buildings or other objects.

## 2.3 Safety functions

The product is equipped with various safety functions that interrupt all dangerous current in the product in the event of certain hazards.

### 2.3.1 Emergency stop button

**WARNING****Danger due to impaired safety function!**

Damage to the emergency stop button can impair the product's safety function!

- Check the function of the emergency stop button at regular intervals (see the "Pressing the emergency stop button" and "Maintenance" sections)!
- Make sure that the emergency stop button is always readily accessible!



**WARNING**

**Danger of fatal electric shock!**

The electrical voltage in the product is dangerous and can cause serious injury or death from electric shock!

The product is live even after the emergency stop button is pressed!

- Completely disconnect the product from all power sources before opening the product or removing cables.
- Do not use the emergency stop button to perform maintenance on the product.

The product is equipped with an emergency stop button. Pressing the emergency stop button causes the following to happen:

1. The contactors in the DC charger are opened, immediately interrupting the electrical connections to the power supply from the AC/DC converters and to the vehicle.
2. A signal is sent to the controller, which makes it impossible to resume charging by resetting the emergency stop button.
3. The message “*Emergency stop pressed*” appears on the LC display.

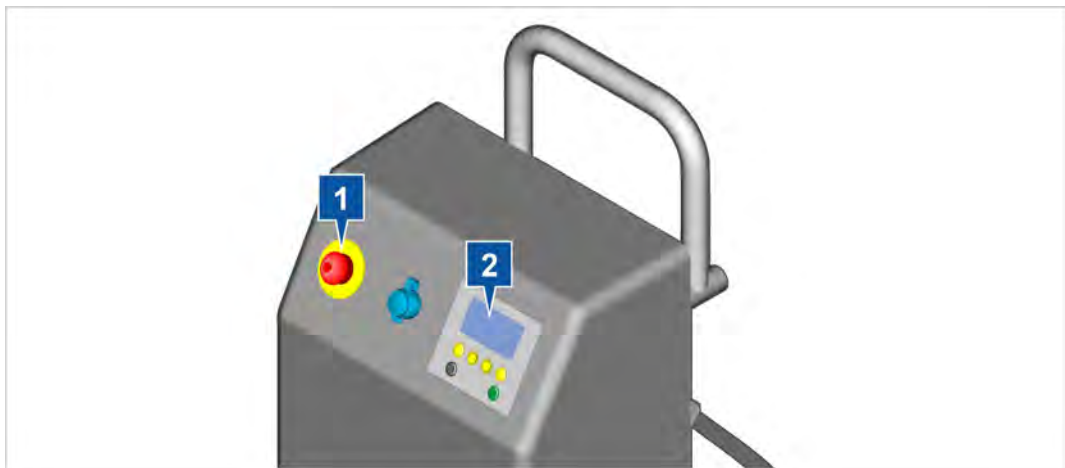

Position	Description
1	Emergency stop button
2	LC display

### Pressing the emergency stop button

Push in the emergency stop button until it clicks into place.

- ✓ The message “*Emergency stop pressed*” appears on the LC display.

### Resetting the emergency stop button

1. Turn the emergency stop button clockwise and pull out until it clicks into place.
2. Press the “On” button.

- ✓ The message “*Emergency stop pressed*” disappears from the LC display.



**You cannot resume a previous charging process by resetting the emergency stop button. You have to restart the product.**

## 2.4

### Intended use

The high-voltage DC charger is a mobile charger for rapidly charging traction batteries in electric vehicles. The high-voltage DC charger is used to charge traction batteries with direct current in charging mode 4.

The high-voltage DC charger has a Combo 2 CCS charging plug, dynamic power adjustment and control and protection functions that make it suitable for all the conventional electric vehicles available on the market.

Use the high-voltage DC charger only on the DC charging socket of your electric vehicle! Connect the high-voltage DC charger only to fused power sockets with protective and neutral conductors!

Use only the extension cables or adapters that the manufacturer has approved for the product!

Any use beyond what is listed here is prohibited!

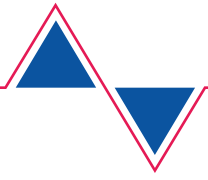

## 2.5 Requirements for the target group



### **DANGER**

#### **Danger of fatal electric shock!**

The electrical voltage in the product is lethal and will cause death by electric shock!

- Keep the product away from children and adolescents!

Only qualified personnel may work with this product!

In this operating manual, qualified personnel is defined as personnel meeting the following requirements:

- Personnel have received comprehensive training on working with electric vehicles.
- Personnel have received training on working with all charging modes, in particular mode 4.
- Personnel must not be under the influence of medication or drugs while using the equipment!

## 2.6 Duties of the operator

The operator is responsible for ensuring that all staff working with the high-voltage charger fulfills the requirements for the target group.

Furthermore, the operator is responsible for ensuring the following:

- The high-voltage charger is always in perfect working order.
- The regular inspection intervals for the high-voltage charger are observed and recorded.
- Replacement of components is logged when the maximum number of mating cycles is reached.

## 2.7 Note to the grid operator

In some countries, you may require a permit from the energy utility to operate electric vehicle charging stations.

- Contact your grid operator before starting up the product.
- Have the grid operator or an electrician check your home's connection to see if it is suitable for operating an electric vehicle charging station.

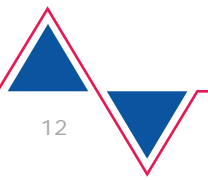

## 3 Transport and storage

### 3.1 Transport on receipt of goods



Immediately check the condition of the product and the completeness of the package. Document any damage that occurred during transportation or customs inspections and contact the carrier or manufacturer immediately.

Observe the following warnings when transporting the product.



#### CAUTION

##### Improper transportation

Transporting the product using unsuitable means can lead to property damage and personal injury!

- Always use a suitable industrial truck or hoist to transport the packaged product!



#### CAUTION

##### Risk of damage!

Slings suspended from indoor cranes can damage the packaging!

- Do not transport the packaged product using slings and indoor cranes.

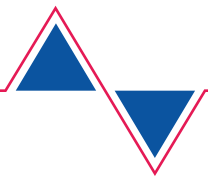

### 3.2 Unpacking the product

The packaging consists of a two-part cardboard box. The lower half is firmly attached to a disposable pallet. Inner packaging within the cardboard box protects the product.



#### CAUTION

##### Risk of injury due to heavy product!

Lifting the product can lead to back injuries.

Body parts can become trapped or crushed when the product is lowered.

- Always use two people to lift the product!
- Always wear protective footwear when transporting the product!



#### CAUTION

##### Risk of damage!

There is a risk of damaging the insulation on the cables.

- When cutting the packaging straps, take care not to cut through the cardboard!
- Carefully remove the protective foil from the cables!

1. Carefully cut the packaging straps.
2. Remove the top half of the heavy duty cardboard box.

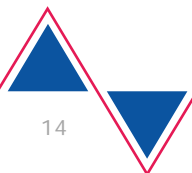
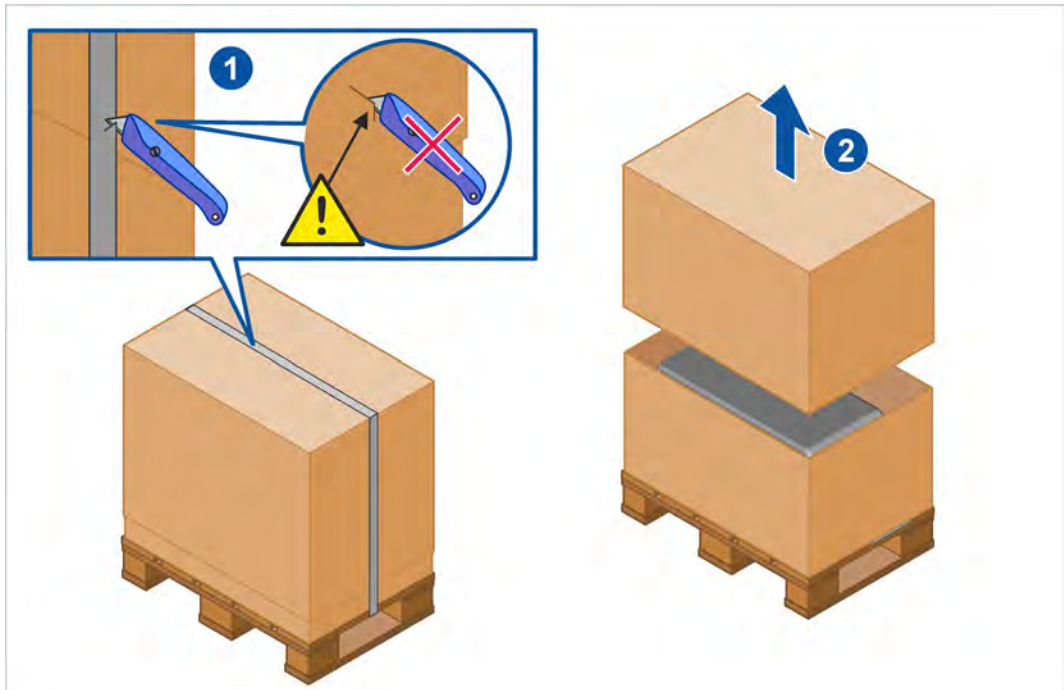

3. Remove the inner packaging.
4. Unfold the front opening of the heavy duty cardboard box.
5. Grasp the product by the handle and pull it out of the heavy duty cardboard box in the horizontal position.
6. Stand the product upright.
  - ⇒ When in the vertical position, the product's own weight engages the parking brakes.
7. Remove the protective foil from the wiring harnesses.

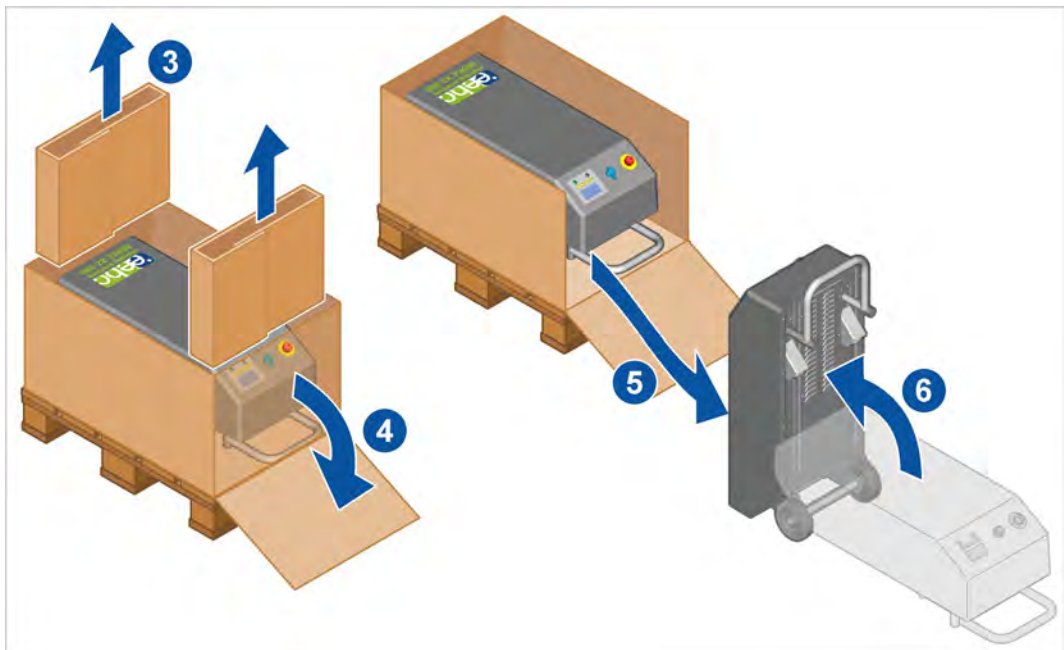

- ✓ The product is now unpacked. Keep the inner packaging and the heavy duty cardboard box for future transportation.
- ✓ You can now check the scope of delivery (see the "Scope of delivery" section).

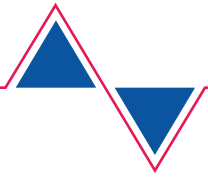

### 3.3 Transporting the product at the place of use

The product is mounted on wheels that allow it to be easily transported to the place of use or storage. Observe the following warnings when transporting the product to the place of use:



#### CAUTION

##### Risk of crushing and bruising!

If not secured, the product can roll away unintentionally on uneven ground!

Body parts can become crushed or bruised!

- Always secure the product by engaging the parking brakes!
- Always wear personal protective equipment and footwear when working on the product!

#### 3.3.1 Engaging the parking brake

The parking brake on the wheels automatically engages as soon as the product is upright. When the product is set down on its front feet, the product's own weight causes the brake to be pressed against the wheels.

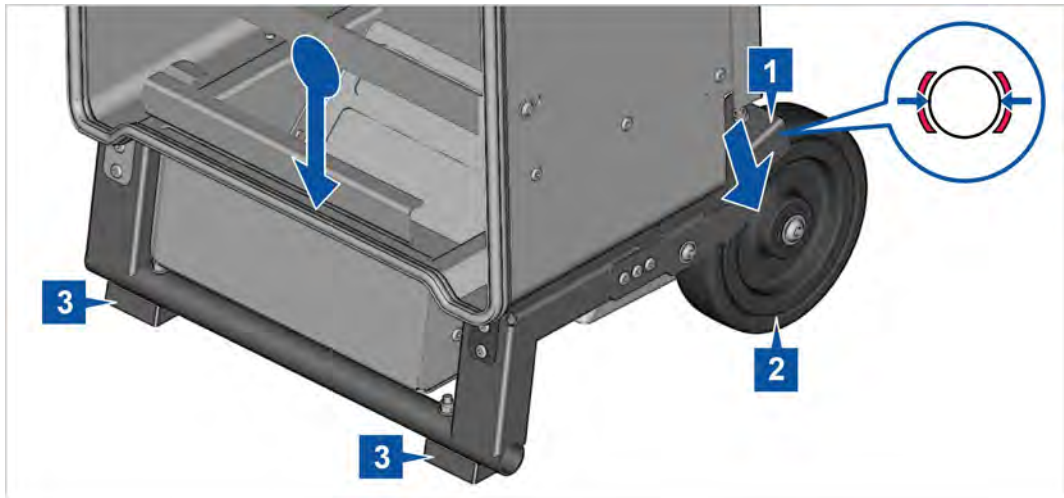

- (1) Parking brake
- (2) Wheel
- (3) Front feet

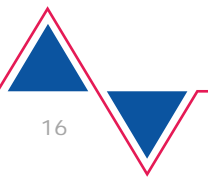



### 3.3.2

### Adjusting the parking brake

This adjustment ensures that the parking brake securely locks the wheels as soon as the product is upright.

**Requirement:**

- The product must be disconnected from the power supply and from the vehicle.
- The product must be resting on a level surface.

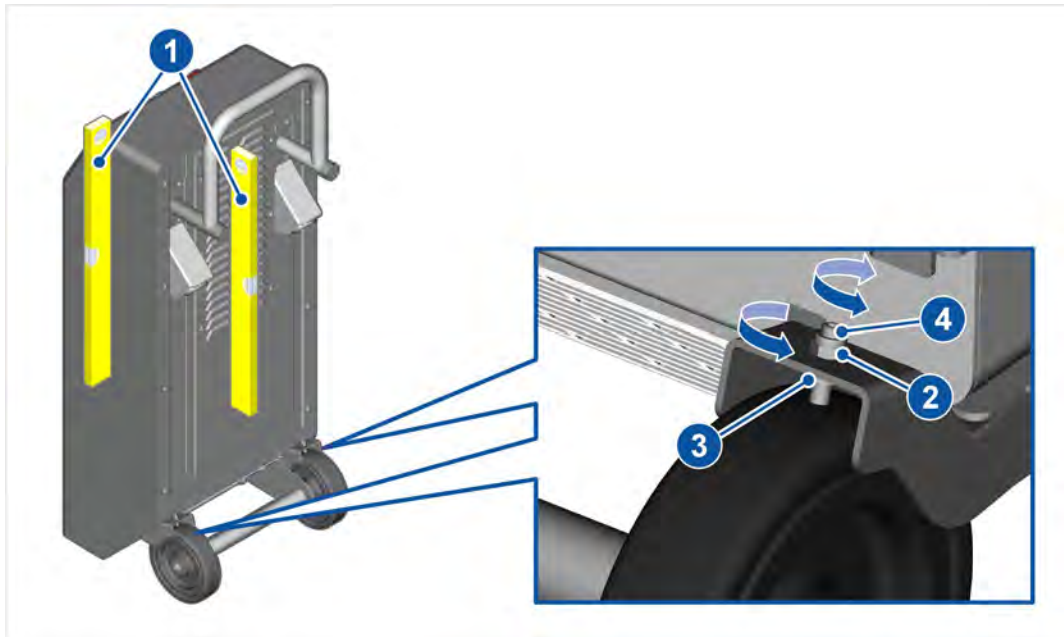

1. Use a spirit level to check that the product is vertical.
  2. Loosen the upper lock nut.
  3. Secure the lower lock nut so that it cannot rotate.
  4. Turn the set screw to adjust the pressure on the wheel so that it fixes it securely in place.
  5. Tighten the upper lock nut.
  6. Check the adjustment and repeat if necessary.
- ✓ The parking brake is now adjusted.

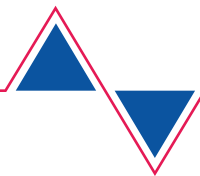

### 3.4 Ambient conditions at the place of use



#### CAUTION

##### Overheating!

If excessive heat is produced, the DC charger automatically switches off!

- Do not expose the product to direct sunlight!
- Ensure that the ventilation grilles are always clear while the product is in operation!
- Always unwind the cables completely!
- Never operate the product in a closed container!
- Never operate the product on carpet or other textile floor coverings!
- Observe the permitted ambient temperatures (see the “Technical data” section)!

To ensure optimum ventilation, always maintain at least one meter of clearance from other bodies and the wall.

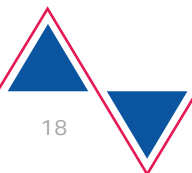
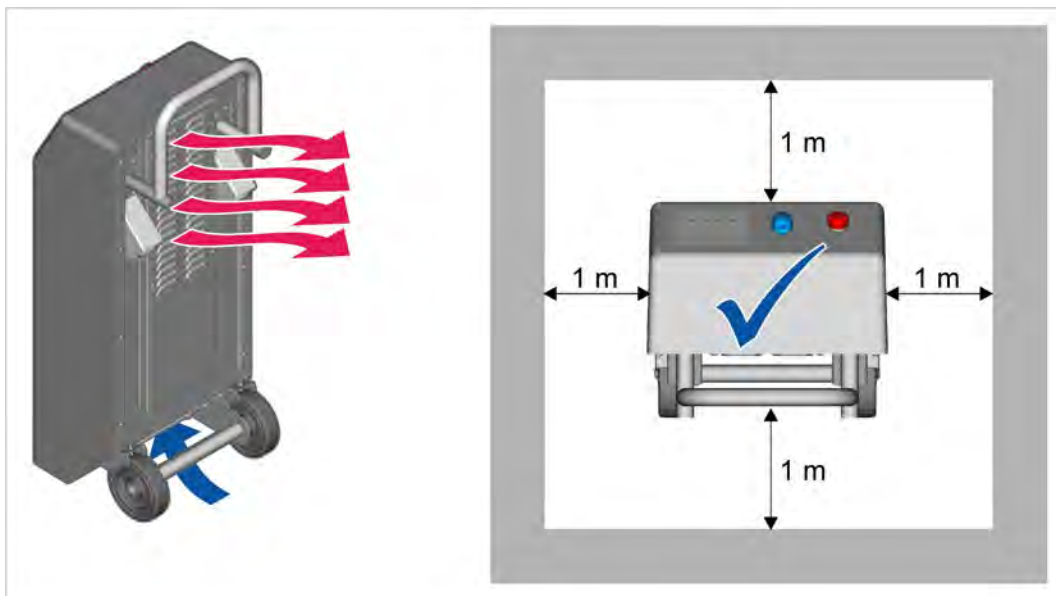

## 4 Product description

### 4.1 Scope of delivery

Immediately check the condition of the product and the completeness of the delivery. If anything is missing or defective, please contact the manufacturer immediately.



- (1) High-voltage DC charger
- (2) USB stick with operating manual

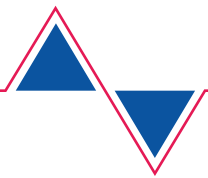

## 4.2

### Design

Product design:

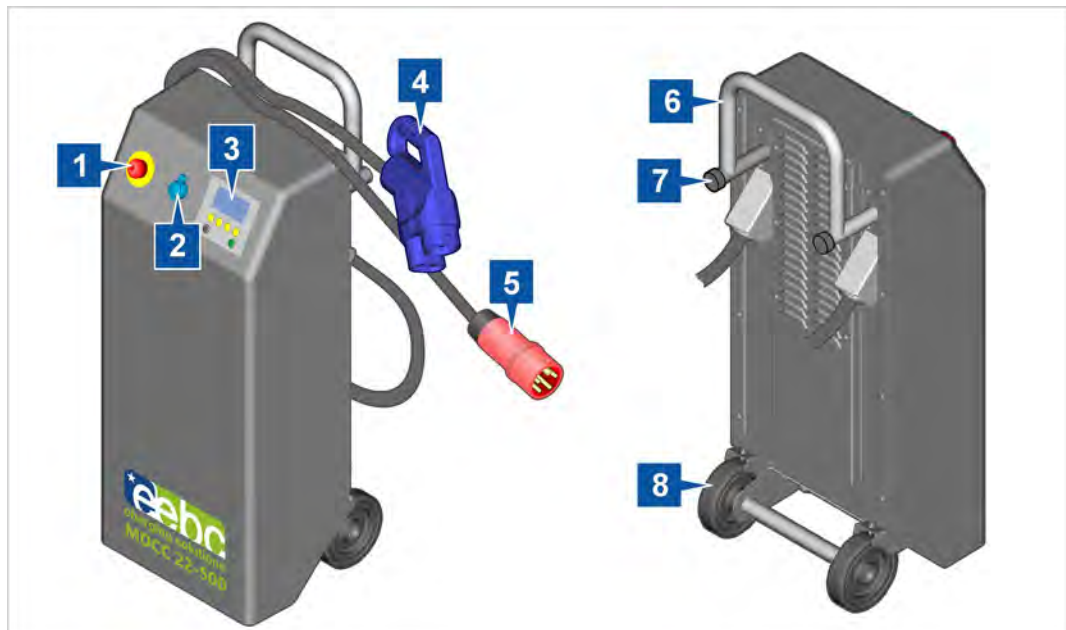

- (1) Emergency stop button
- (2) Service port
- (3) LC display with membrane keypad
- (4) CCS charging plug
- (5) Power supply plug
- (6) Handle
- (7) Rubber cushion
- (8) Wheels

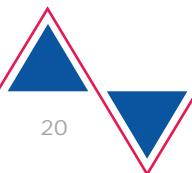

## 4.3 Symbols and connections



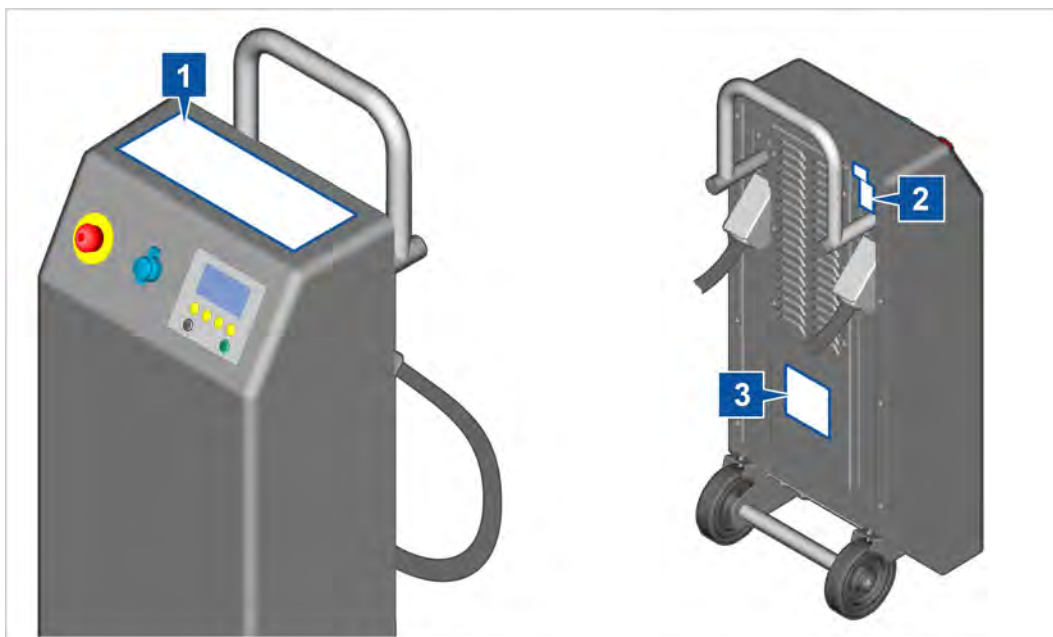

The product is equipped with the following stickers:

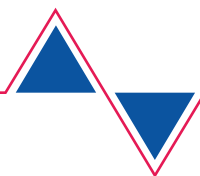

Position	Description	Function
1	Quick start guide	The nonverbal quick start guide describes the steps needed to charge a traction battery. The quick start guide is not a substitute for reading the operating manual!
2	Warranty seal	Opening the product or damaging or removing the warranty seal will void the manufacturer's warranty for your product.
3	Nameplate	The nameplate contains information about the manufacturer, the product type, the year of manufacture and the serial number. You can use the serial number to track information relating to production.



The following symbols and information are shown on the product stickers:

Symbol	Meaning
	Electrical hazard!
	Read the operating manual!
SN:	The serial number is used in conjunction with the manufacturer part number to identify the product.
AC / ~	The “AC” and “Phase (~)” markings indicate that the product must be connected only to alternating current sources.
IP42	<ul style="list-style-type: none"> <li>The product is protected against falling water droplets, provided the housing is not tilted more than 15°.</li> <li>The product is protected against solid foreign objects with a diameter of at least 1 mm.</li> </ul>
	The disposal instructions prohibit disposal of the product with household waste. Always dispose of the product in accordance with all local disposal regulations.
	This marking indicates that the product must not be operated outdoors.
	QR code for accessing the operating manual on mobile devices.

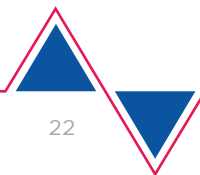

## 4.4

**Displays and controls**

The product is equipped with the following displays and controls:

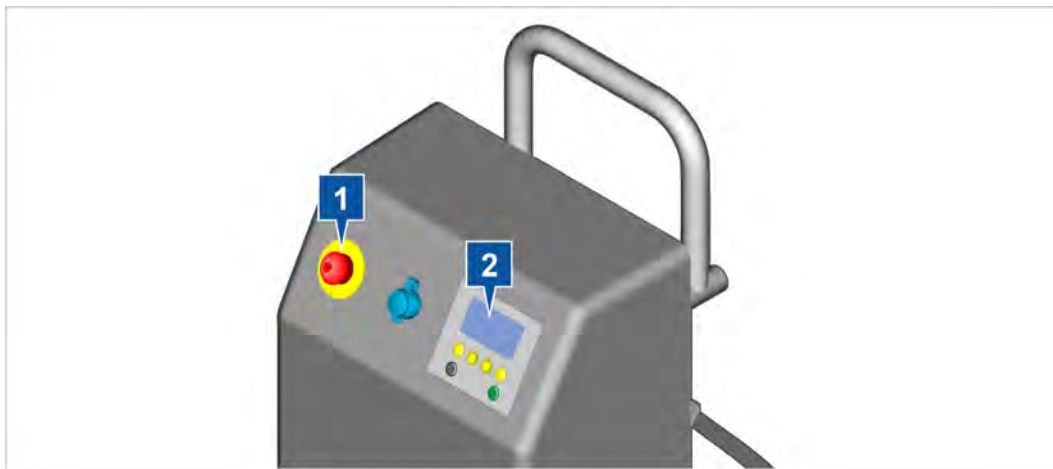

Position	Description	Function
1	Emergency stop button	<ul style="list-style-type: none"> <li>Immediately interrupts all hazardous currents. The exact function of the emergency stop button is described in the "Safety" section.</li> </ul>
2	LC display with membrane keypad	<ul style="list-style-type: none"> <li>Displays the operating status</li> <li>Controls charging functions</li> </ul>

The individual functions of the LC display and the method for operating the membrane keypad are described in the "Operation" section.

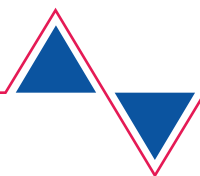

## 4.5 Technical data

Rated data	Values
Manufacturer number	22103228
Power supply connection	3P/N/PE   plug: CEE 32 (red)
Permitted grid design	TN-C-S grid / TN-S grid
Input voltage	AC 323 V – AC 437 V, 45 – 65 Hz
Power supply connection circuit breaker	32 A/phase   RCD 30 mA
Output voltage	DC 500 V
Device output	22 kW
Charging current	Max. 50 A
Charging mode	Mode 4 with “Combo 2” CCS plug
Efficiency	> 95%
Weight	~ 43 kg
Dimensions L/H/W	~ 342 mm/920 mm/305 mm
Cable length	Power supply side: 4.5 m, vehicle side: 7.5 m
Degree of protection	IP42

Ambient conditions	Operation	Storage	Transportation
Temperature	-25°C to 40 C	-20°C to 60°C	-20°C to 60 C
Elevation above sea level	Max. 2000 m	No limitation.	
Humidity	Max. 80% up to 31 °C, decreasing linearly to 50% at 40 °C.		
	Condensation not permitted. Maximum permissible relative humidity: 60% in environments with corrosive gas/air.		

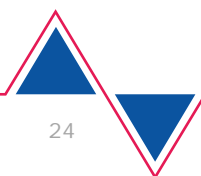



## 5 Operation

This section provides information about the following activities:

- Preparing the power supply connection
- Startup
- Initial startup
- Starting charging
- Finishing charging
- Using the LC display
- Troubleshooting
- Cleaning
- Storage
- Disposal
- Maintenance

### 5.1 Preparing the power supply connection



#### **WARNING**

##### **Danger of fatal electric shock!**

The electrical voltage in electrical installations is lethal and can cause death by electric shock!

Unprofessional and faulty electrical installations may result in short circuits and cable burnouts!

- Use only electrical installations that comply with the national guidelines for the installation of low-voltage systems!
- Connect the product only to grounded electrical installations with protective and neutral conductors!
- Do not use extension cables and use only adapters approved by the manufacturer to connect the product to the power supply!

A safe and suitable power supply connection that complies with the applicable standards is required to ensure that the traction battery can be charged safely.

The following illustration of a power supply connection is provided as an example and may differ from your particular situation. This has no effect on the steps to be performed.



- (1) Miniature circuit breakers
- (2) Three-phase power supply connection
- (3) Residual-current device (RCD)

Carry out the following inspections to check the power supply connection:

1. Always check the general condition of the electrical installation. Check the condition of the three-phase power supply connection and the Schuko sockets.
  2. Check that the miniature circuit breakers and the residual-current device comply with the product specifications (see chapter “Technical data”).
- ✓ You cannot operate the product on this power supply until all the checks have been performed successfully.

## 5.2

### Startup

This section provides you with information about starting up and operating the product.



#### CAUTION

##### Tripping hazard!

Tripping over exposed cables or the housing may result in physical injury!

- Warn other persons about exposed cables and the housing!
- Never block traffic or escape routes!
- Position the vehicle next to the power supply!
- Ensure that persons do not enter the area where the product is being used without due care!
- Take special care when entering the area where the product is being used!

## 5.3

### Initial startup

This section explains the actions you must perform when starting up the product for the first time.

1. Follow the general safety instructions.



2. Insert the three-phase plug all the way into the three-phase socket. Observe the keying on the plug!

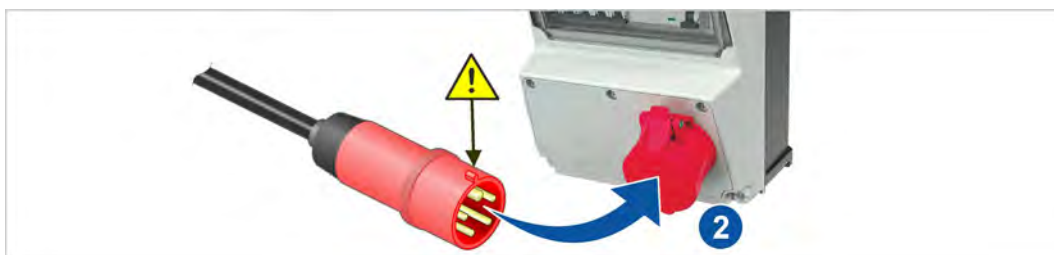

- ⇒ The high-voltage DC charger starts up automatically once connected to the power supply.
  - ⇒ The message “*Language*” appears on the LC display. Below this is the language currently set on the high-voltage DC charger.
3. Use function keys F2 and F3 to select the desired language.
  4. Confirm your selection with function key F4.
- ✓ The language is now set on the high-voltage charger.
  - ✓ The high-voltage DC charger starts the self-test.

### 5.3.1

#### Cold start

A cold start is when you start up the high-voltage DC charger after it has been disconnected from the power supply.

This section explains the actions required to carry out a cold start of the product.

To carry out a cold start, perform the steps for initial startup, with the exception of steps 3 and 4.

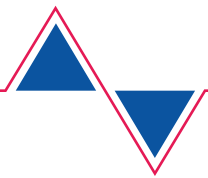

### 5.3.2 Warm start

You can carry out a warm start of the high-voltage DC charger when the charger is switched off but connected to the power supply.

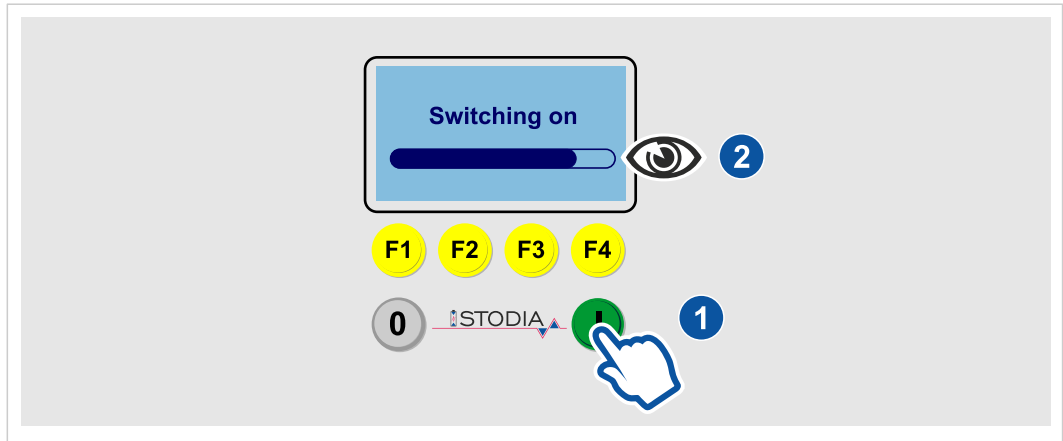

1. Press and hold the “On” button.
  - ⇒ The message “*Switching on*” and a progress bar appear on the LC display.
2. Press and hold the “On” button until the progress bar reaches 100%.
  - ✓ The high-voltage DC charger performs a self-test in the background.

### 5.3.3 Setting the contrast

In order to see the information on the LC display better, you can adjust the contrast to suit the ambient conditions.

This chapter explains how to adjust the contrast of the LC display.

Requirement:

- The DC charger must be switched on (see the “Cold start” and “Warm start” chapters).
1. In the main menu, open the “*Configuration parameters*” submenu by pressing function key F1.



2. Navigate to the “*Contrast*” parameter by pressing function keys F2 (down) and F3 (up).
3. Select the “*Contrast*” parameter to edit by pressing function key F4 (select).

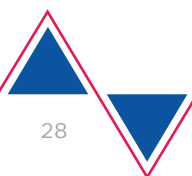

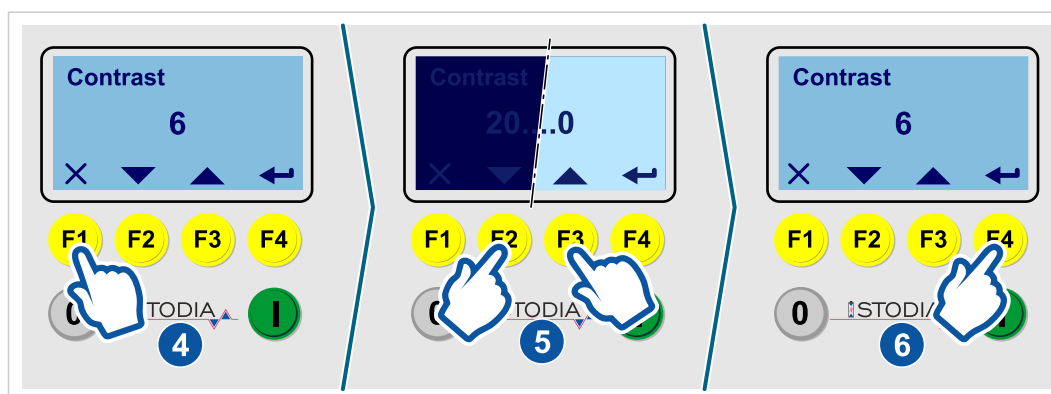

4. If the LC display is easy to read or if you do not achieve a better setting with the following step, exit this setting by pressing function key F1 (cancel).
  5. Change the contrast by pressing function keys F2 (down) and F3 (up) within the limits 0 to 20.
  6. Confirm the set contrast value by pressing function key F4 (confirm).
- ✓ You have successfully set the contrast of the LC display.

### 5.3.4 Startup after long downtimes

The high-voltage DC charger switches off automatically when it is not operated for a long period of time (factory setting: 24 hours). In this case, you must carry out a warm start of the high-voltage DC charger (see the “Warm start” section).

### 5.3.5 Self-test

The high-voltage DC charger runs a self-test in the background as soon as you start it up.

During the self-test, the product tests all electrical systems required for safety and proper functioning. The self-test takes only a few seconds.

While the self-test is ongoing, you can already control certain functions using the function keys (see the “Using the LC display” section).

If malfunctions are detected during the self-test, they are indicated on the LC display (see the “Troubleshooting” section).

- ✓ At the end of a successful self-test, the messages “*Connect vehicle*” and “*Ready*” appear on the LC display in alternation.
- ✓ You can now begin the charging process.

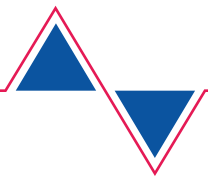

## 5.4 Starting charging

### 5.4.1 Setting the charging time

Before beginning charging, you can set the maximum charging time on the LC display.

Requirement:

- The DC charger must be switched on (see the “Cold start” and “Warm start” chapters).
  - Charging must not be active.
1. In the main menu, open the “*Configuration parameters*” submenu by pressing function key F1.



2. Navigate to the “*Charging time*” parameter by pressing function keys F2 (down) and F3 (up).
3. Select the “*Charging time*” parameter to edit by pressing function key F4 (select).

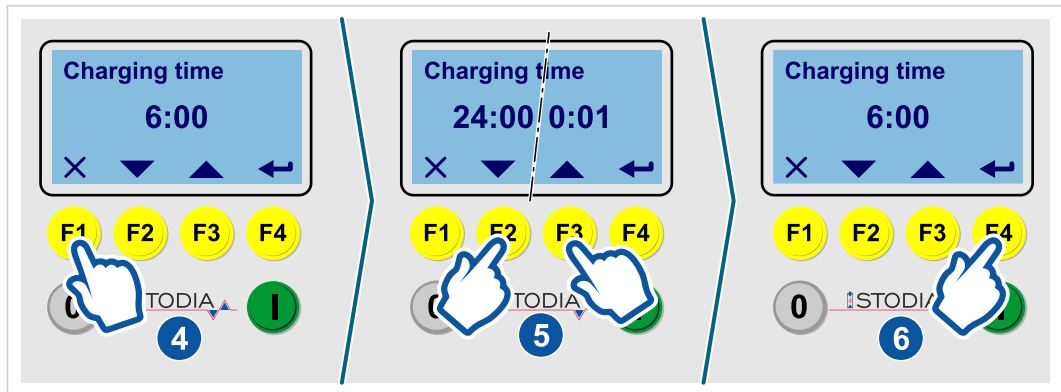

4. If the preset value is correct, exit this setting by pressing function key F1 (cancel).
  5. Change the charging time by pressing function keys F2 (down) and F3 (up) within the limits 0:01 and 24:00 (hh:mm format).
  6. Confirm the set value by pressing function key F4 (confirm).
  7. Exit the parameter menu by pressing function key F1 (exit).
- ✓ You have successfully set the charging time for the DC charger.

### 5.4.2 Setting the auto-off function

To conserve energy, you can set the DC charger to automatically switch off after a specified time.

Requirement:

- The DC charger must be switched on (see the “Cold start” and “Warm start” chapters).
  - Charging must not be active.
1. In the main menu, open the “*Configuration parameters*” submenu by pressing function key F1.

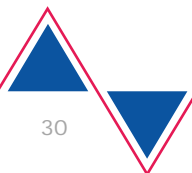

2. Navigate to the “Auto-off” parameter by pressing function keys F2 (down) and F3 (up).
3. Select the “Auto-off” parameter to edit by pressing function key F4 (select).

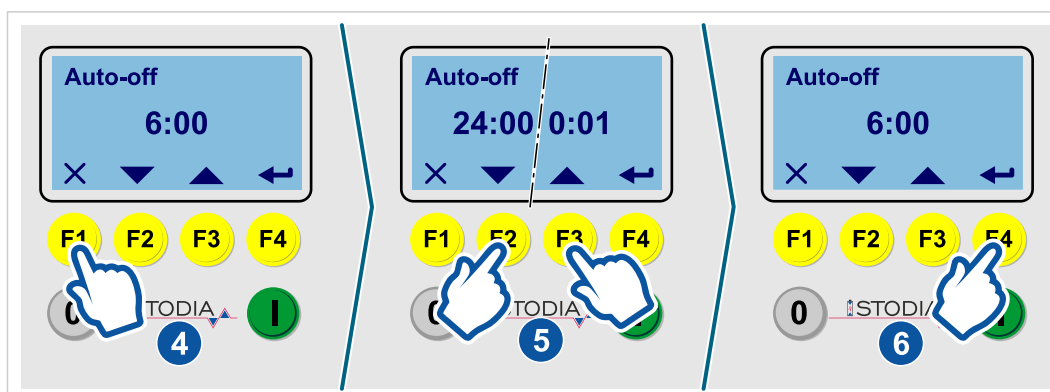

4. If the preset value is correct, exit this setting by pressing function key F1 (cancel).
5. Change the switch-off time by pressing function keys F2 (down) and F3 (up) within the limits 0:01 and 24:00 (hh:mm format).
6. Confirm the set value by pressing function key F4 (confirm).
7. Exit the parameter menu by pressing function key F1 (exit).
- ✓ You have set the auto-off function of the DC charger.

### 5.4.3 Charging the vehicle

1. Follow the general safety instructions.
2. Follow all instructions for mode 4 charging that are included in the operating manual from the vehicle manufacturer.



3. Insert the “Combo 2” CCS charging plug all the way into the charging socket on your vehicle.  
⇒ The message “Preparing charging” appears on the LC display.

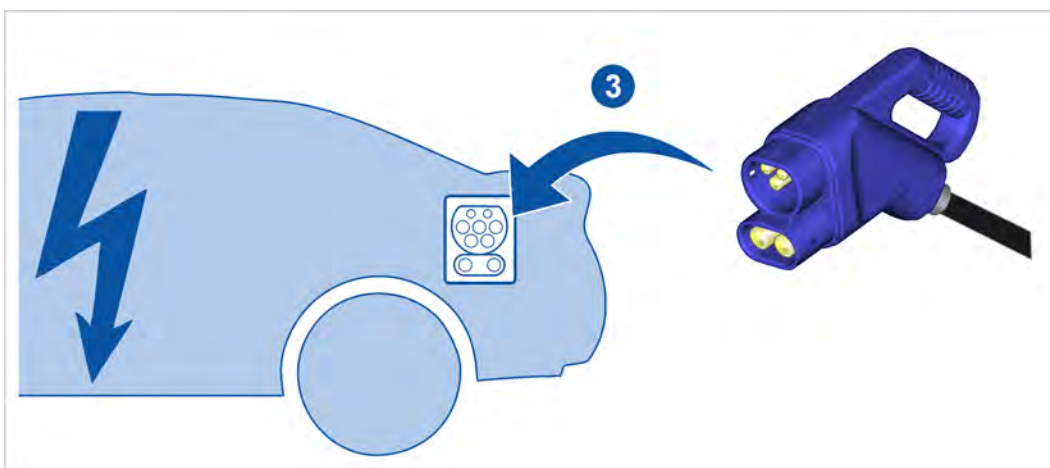

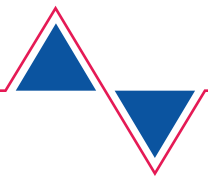



4. If necessary, start the charging process on the vehicle as described in the operating manual from the vehicle manufacturer.
- ✓ The charging process starts automatically once the high-voltage DC charger has established communication with the battery management system.

## 5.5 Finishing charging

### 5.5.1 Waiting for charging to finish

During the charging process, the following charging information appears on the LC display:

Symbol	Meaning	Unit
	State of charge	%
	Remaining charging time	h
	Charging power	kW

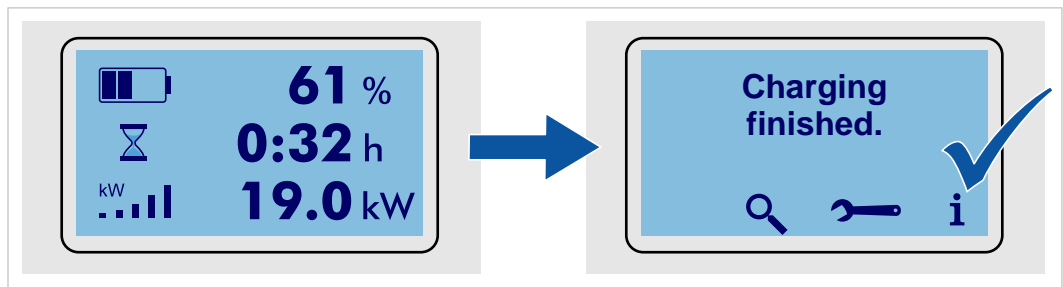

The icons in the main menu are hidden during charging but can still be accessed using the function keys F2 to F4 (see the “Main menu” section).

- ✓ The message “Charging finished” appears on the LC display once the charging process is completed.

### 5.5.2 Canceling the charging process



#### WARNING

##### Danger of fatal electric shock!

Product components may produce sparks and electric arcs!

- Never disconnect high-voltage plug connections while under load!
- Finish the charging process before disconnecting the plug connections!

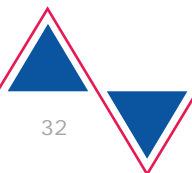



You can cancel charging at any time during an active charging process.

1. Press and hold the “Off” button.
  - ⇒ The message “Stop” and a progress bar appear on the LC display.

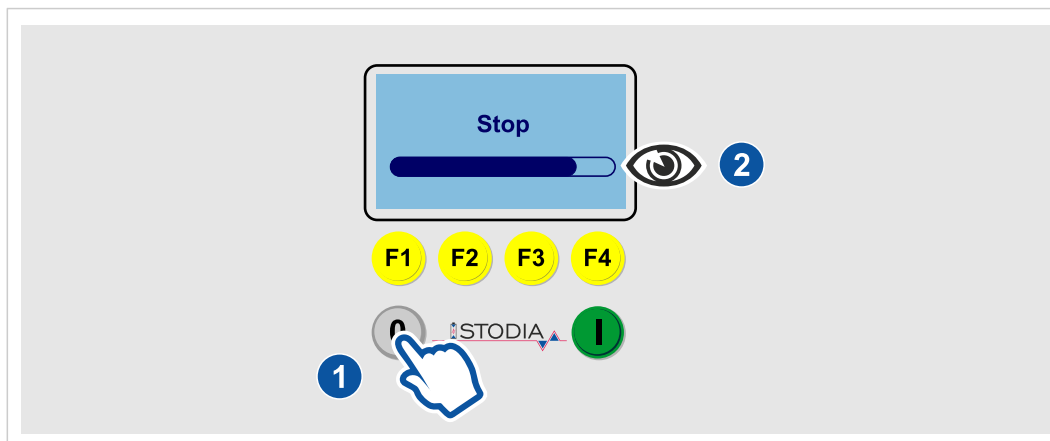

2. Press and hold the “Off” button until the progress bar reaches 100%.
    - ⇒ The DC high-voltage charger cancels the charging process.
    - ⇒ After a few seconds, the message “Disconnect vehicle” appears on the LC display.
  3. Once the message “Disconnect vehicle” appears on the LC display, pull the type 2 CCS charging plug from the charging socket on your vehicle.
- ✓ Charging has now been canceled.

### 5.5.3 Switching off the charger

If the device is not actively charging, you can switch it off to save energy.

1. Press and hold the “Off” button.
  - ⇒ The message “Stop” and a progress bar appear on the LC display.

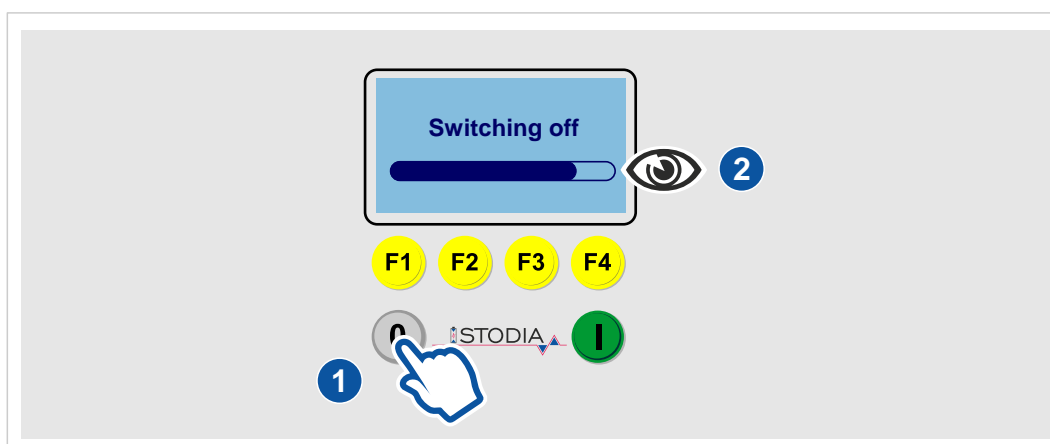

2. Press and hold the “Off” button until the progress bar reaches 100%.
- ✓ You have successfully switched off the high-voltage DC charger.

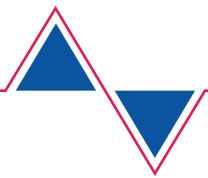









## 5.6 Using the LC display

### 5.6.1 Function keys

The function keys F1 to F4 are arranged below the LC display.

You can use the function keys to navigate through the menu on the LC display, make settings and change parameters. Each function key is assigned a situation-specific function, which is shown on the LC display directly above the respective function key.

The function keys can be assigned the following functions:

Function key	Assignment	Function
F1		<b>Back:</b> Exit the current setting.
		<b>Delete:</b> Delete the set parameter.
F2		<b>Detail:</b> Display the operating parameters.
		<b>Down:</b> Scroll down through the selection options.
F3		<b>Up:</b> Scroll up through the selection options.
		<b>Wrench:</b> Display the configuration parameters.
F4		<b>Info:</b> Display the information parameters.
		<b>Select:</b> Select the highlighted menu item.
		<b>Confirm:</b> Confirm the set parameter.

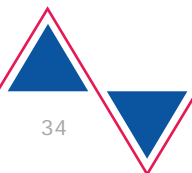

5.6.2

Menu structure

The figure below shows the menu structure and how you can navigate within it. The individual parameters are described in the tables below.

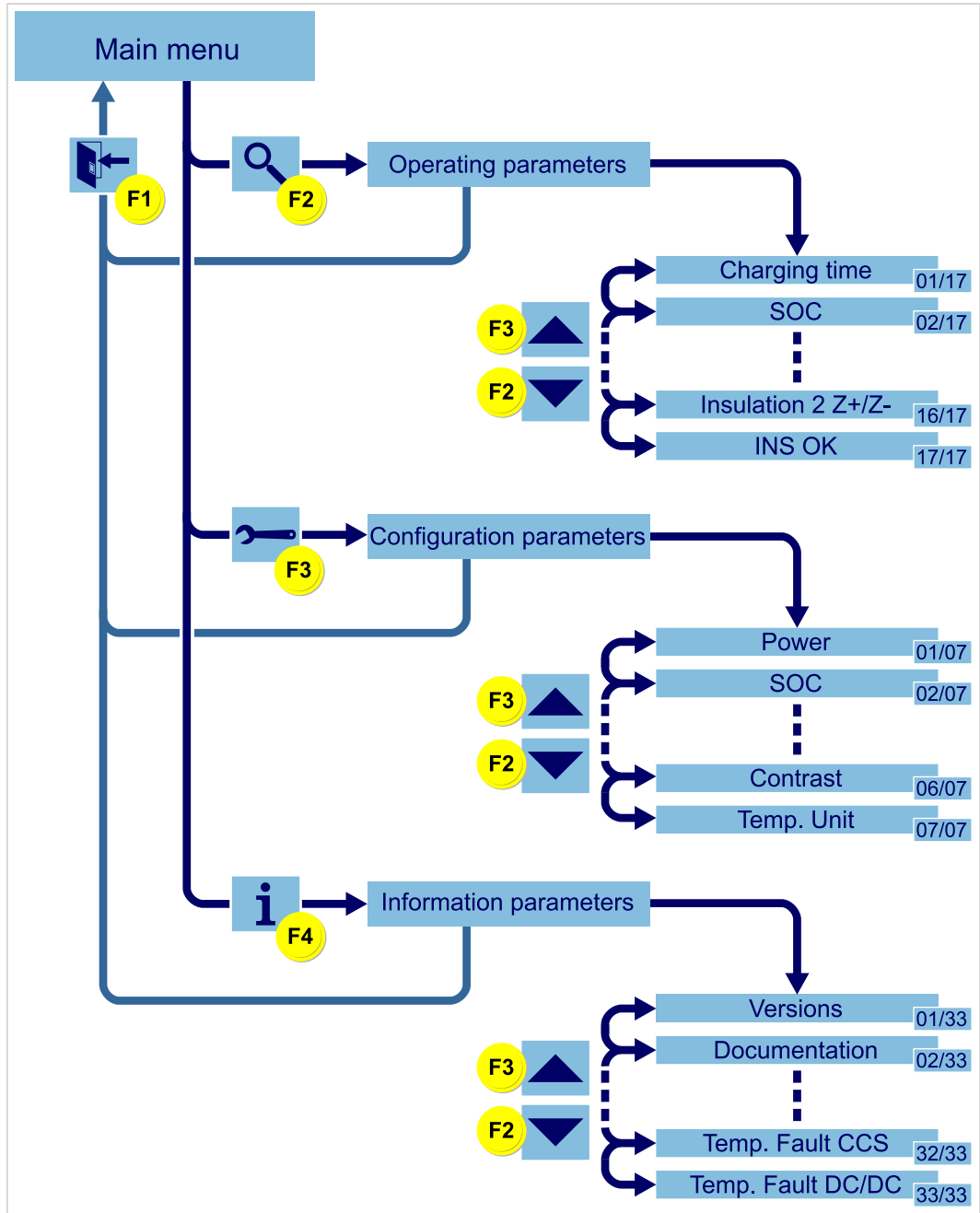

The “Configuration parameters” menu is not available while charging is active.

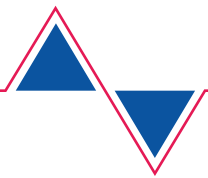



### 5.6.3 Main menu

From the main menu, press function keys F2 to F4 to access the following submenus. Exit the submenu by pressing function key F1 (exit).

Function key	Assignment	Function
F2		Display the operating parameters. The operating parameters are used to monitor the charging process (see the “Operating parameters” section).
F3		Display the configuration parameters. You can adjust the parameters in this area (see the “Configuration parameters” section).
F4		Displays the information parameters (see the “Information parameters” section).

### 5.6.4 Operating parameters

The “*Operating parameters*” submenu displays the current parameters for the charging process. The parameters are sequentially numbered and are explained in the following table.

1. Navigate through the parameters by pressing function keys F2 (down) and F3 (up).
2. Exit the parameter menu by pressing function key F1 (exit).

Parameter	Values	Meaning	Unit
<i>Charging time</i>	<b>Act</b>	The elapsed charging time	min.
	<b>End</b>	The remaining charging time	
SOC ( <i>State of Charge</i> )	<b>Set</b>	State of charge at which the charging process is terminated	%
	<b>Act</b>	Current state of charge	
<i>Power</i>	<b>Max</b>	Maximum output power of the high-voltage DC charger	kW
	<b>Act</b>	Current output power of the high-voltage DC charger	
<i>Counter</i>		Amount of energy delivered during the charging process	kWh
		Electrical charge delivered during the charging process	Ah
<i>Protocol</i>		Displays the charging communication protocol used	

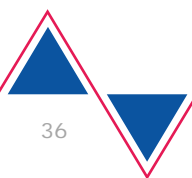

Parameter	Values	Meaning	Unit
<i>Charge phase</i>		Status of the charging process.	
<i>Voltage</i>	<b>Max</b>	Charging end voltage	V
	<b>Act</b>	Current voltage at the output of the high-voltage DC charger	
<i>Current</i>	<b>Set</b>	Maximum possible charging current of the high-voltage DC charger	A
	<b>Act</b>	Current charging current of the high-voltage DC charger	
	<b>Output</b>	Temperature at the DC output of the high-voltage DC charger	
<i>Temp. GB/T</i>	<b>DC+</b>	Temperature at the positive pin of the GB/T plug	°C
	<b>DC-</b>	Temperature at the negative pin of the GB/T plug	
<i>Temp. DC/DC</i>		Temperature of AC/DC converters 1 and 2	°C
<i>Temp. Derating</i>		Indicates the power reduction due to temperature limits.	%
<i>Insulation 1 Z+/Z-</i>		Resistance values between DC+, PE and DC-	kΩ/MΩ
<i>Insulation 2 Z+/Z-</i>		Resistance values as a function of the actual voltage	kΩ/V
<i>INS OK</i>		Insulation monitoring status	

### 5.6.5 Configuration parameters

The “*Configuration parameters*” submenu lets you set country-specific and charge-specific parameters.

1. Navigate through the parameters by pressing function keys F2 (down) and F3 (up).
2. Select a parameter to edit by pressing function key F4 (select).
3. Change the parameter value by pressing function keys F2 (down) and F3 (up).
4. Confirm the new parameter value by pressing function key F4 (confirm).
5. Exit the parameter menu by pressing function key F1 (exit).

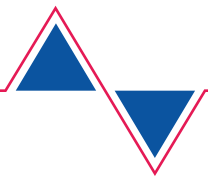

Parameter	Meaning	Unit	Factory setting
<i>Power</i>	Device power limit	<b>kW</b>	22
<i>SoC limit</i>	Maximum state of charge	<b>%</b>	100
<i>Charging time</i>	Maximum charging time	<b>h</b>	24
<i>Auto-off</i>	Time after which the high-voltage DC charger switches off automatically after charging is finished	<b>h</b>	24
<i>Language</i>	Menu language		German
<i>Contrast</i>	Contrast of the LC display		6
<i>Temp. Unit</i>	Unit in which temperatures are shown on the LC display	<b>°C</b>	Degrees Celsius

### 5.6.6 Information parameters

The “*Information parameters*” submenu contains all operating parameters, fault messages and device actions grouped together. All actions performed on the high-voltage DC charger are recorded and stored here.

The parameters in this menu serve as the basis for maintenance intervals and fault diagnostics and cannot be changed.

1. Navigate through the parameters by pressing function keys F2 (down) and F3 (up).
2. Exit the parameter menu by pressing function key F1 (exit).

Parameter	Meaning	Unit
<i>Versions</i>	Software versions of the components	
<i>Serial number</i>	Serial number of the product	
<i>Total time</i>	Total operating hours elapsed	<b>h</b>
<i>Standby time</i>	Standby time in hours without a charging process	<b>h</b>
<i>Charging time</i>	Time taken to deliver the charging power	<b>h</b>
<i>Chg. time Service</i>	Time which is reset during servicing	<b>h</b>
<i>Charge</i>	Total ampere hours delivered	<b>Ah</b>
<i>Energy</i>	Total energy delivered	<b>kWh</b>
<i>Charge count</i>	Number of real charging processes measured	
<i>Total mating cycles</i>	Total number of connector mating cycles	

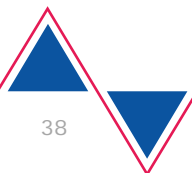

Parameter	Meaning	Unit
<i>Mating cycles</i>	Number of mating cycles for the DC plug	
<i>Cold starts</i>	Number of device starts by connecting the power supply plug	
<i>Warm starts</i>	Number of starts from standby mode	
<i>AC relay cycles</i>	Number of closing cycles for the AC relay	
<i>DC relay cycles</i>	Number of closing cycles for the DC relay	
<i>Temp. GB/T MaxGB/T Max</i>	Maximum temperature at the GB/T charging plug	°C
<i>Temp. AC/DC MaxAC/DC Max</i>	Maximum temperature at the AC/DC converter	°C
<i>T. derating 1</i>	Number of deratings by the AC/DC converter	
<i>T. derating 2</i>	Number of deratings by the controller	
<i>Insulation fault</i>	Number of faults during the insulation test	
<i>Emcy stop</i>	Number of times the emergency stop button has been pressed during operation	
<i>Emcy stop load</i>	Number of times the emergency stop button has been pressed in load situations	
<i>Over- circuit is de-energized</i>	Number of “Overvoltage in the DC circuit (>DC 750 V)” faults	
<i>N fault</i>	Number of “Neutral conductor not detected” errors	
<i>Phase fault</i>	Number of “Phase fault” errors	
<i>Temp.fault GB/T</i>	Number of overtemperature violations at the GB/T charging plug	
<i>Tmp. Fault DC/DC</i>	Number of overtemperature violations at the AC/DC converter	

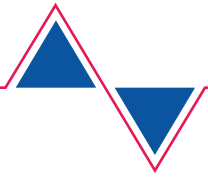

### 5.6.7 Restoring the factory settings

In isolated cases or if the product is used in other workshops, it may be necessary to reset the high-voltage DC charger to the factory settings.

1. Carry out a cold or warm start (see the “Cold start” or “Warm start” section).
2. As soon as the message “*Connect vehicle*” appears, press function keys F1 to F4 simultaneously.
  - ⇒ The message “*Factory settings*” and a progress bar appear.
3. Press and hold function keys F1 to F4 until the progress bar reaches 100%.

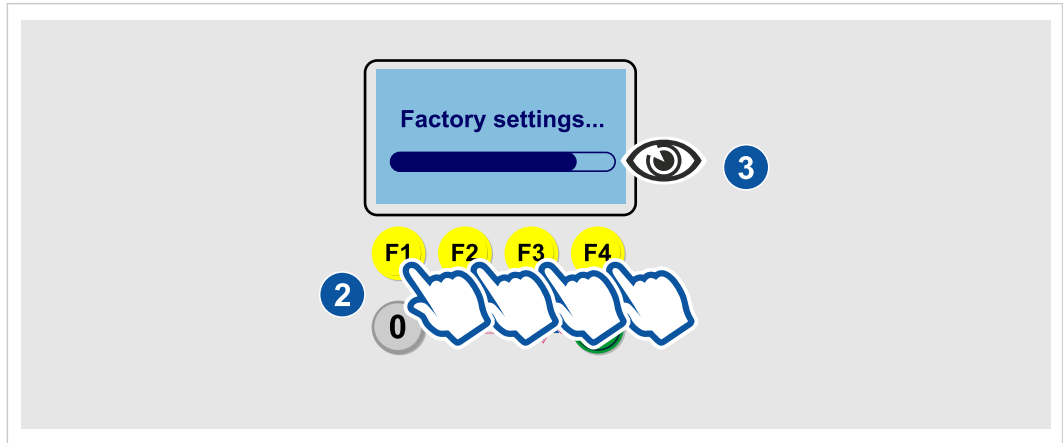

- ✓ You have successfully loaded the factory settings. The language of the LC display has been changed to English.

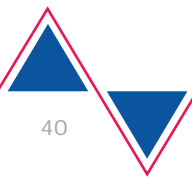



## 5.7

### Troubleshooting

The DC high-voltage charger outputs the following types of message on the LC display:

- Warning messages: These messages, if disregarded, will cause the product to lock, which can then only be reset by the manufacturer. Always carry out the instructions in the warning messages immediately or contact the manufacturer (see the “Warning messages” section).
- Fault messages: In most cases, these messages indicate that a limit value has been exceeded. Remedy the cause of the fault message according to the instructions below (see the “Fault messages” section).



#### DANGER

##### Danger of fatal electric shock!

Defective and damaged products can no longer guarantee protection against electrical voltage!

The electrical voltage in the product is lethal and will cause death by electric shock!

- Switch off the circuit breakers for all the connected sockets before you disconnect the product from the power supply!
- Replace a defective or damaged product immediately!
- Never attempt to repair or tamper with the product!

### 5.7.1

#### Warning messages

The table below provides information about the steps you must take to resolve the cause of these warning messages. Always carry out the instructions in the warning messages immediately or contact the manufacturer.

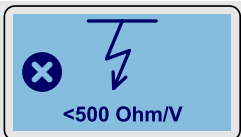
Message	Meaning	Corrective action
<i>Service CCS plug</i>	The CCS charging plug has reached the maximum number of mating cycles	<p>The CCS charging plug is a wearing part and must be replaced after 15,000 mating cycles.</p> <p>When this message first appears, the CCS charging plug still has a maximum of 100 mating cycles left.</p> <p>The high-voltage DC charger locks when the CCS charging plug reaches the maximum number of mating cycles.</p> <p>Contact the manufacturer before reaching the maximum number of mating cycles!</p>
	An insulation fault was detected in the connection to the vehicle.	<p>By the operator or a high voltage specialist:</p> <ul style="list-style-type: none"> <li>• Inspect the vehicle.</li> <li>• Perform vehicle diagnostics.</li> </ul>

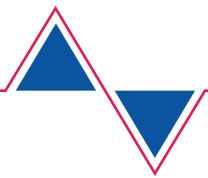

The table below provides information about the steps you can take to resolve these faults. It may be necessary to finish charging first (see the “Finishing charging” section).

If the fault messages cannot be resolved, contact the manufacturer immediately.

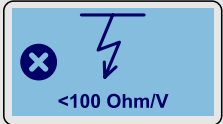
Message	Meaning	Corrective action
	An insulation fault was detected in the connection to the vehicle.	By the operator or a high voltage specialist: <ul style="list-style-type: none"> <li>Inspect the vehicle.</li> <li>Perform vehicle diagnostics.</li> </ul>
<i>Overvoltage</i>	The voltage in the DC circuit is above DC 600 V. The device switches off automatically.	By the operator or a high voltage specialist: <ul style="list-style-type: none"> <li>Inspect the vehicle.</li> </ul>
<i>Fault AC/DC</i>	The AC/DC converters cannot be controlled.	By an electrician: <ul style="list-style-type: none"> <li>Check the power supply connection.</li> </ul> By the operator: <ul style="list-style-type: none"> <li>Contact the manufacturer.</li> </ul>
<i>EMERGENCY STOP pressed</i>	The emergency stop button was pressed.	Remedy the reason for the emergency stop button being pressed and restart the charging process.
<i>N conductor fault</i>	A fault was detected in the neutral conductor in the AC circuit.	By an electrician: <ul style="list-style-type: none"> <li>Check the power supply connection.</li> </ul> By the operator: <ul style="list-style-type: none"> <li>Check the miniature circuit breakers for the power supply connection.</li> <li>Contact the manufacturer.</li> </ul>
<i>Phase fault</i>	There is a fault in at least one phase in the AC circuit.	By an electrician: <ul style="list-style-type: none"> <li>Check the power supply connection.</li> </ul> By the operator: <ul style="list-style-type: none"> <li>Contact the manufacturer.</li> </ul>
<i>CCS temp. fault</i>	The permissible temperature was exceeded at the CCS charging plug.	By the operator: <ul style="list-style-type: none"> <li>Check the number of mating cycles for the CCS charging plug. Replace the CCS charging plug if necessary.</li> <li>Contact the manufacturer.</li> </ul>
<i>Temp.fault AC</i>	The permissible temperature was exceeded at the converters' AC input.	By the operator: <ul style="list-style-type: none"> <li>Check the ambient conditions at the place of use.</li> </ul>

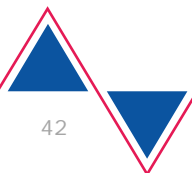

Message	Meaning	Corrective action
<i>Temp.fault DC</i>	The permissible temperature was exceeded at the converters' DC output.	By the operator: <ul style="list-style-type: none"> <li>• Check the ambient conditions at the place of use.</li> <li>• Reduce the charging power (see the "Configuration parameters" section, "Power" parameter).</li> </ul>

## 5.8 Cleaning



### **DANGER**

#### **Danger of fatal electric shock!**

The electrical voltage in high-voltage systems is lethal and will cause death by electric shock!

- Disconnect the product from all power sources before cleaning the product!

Observe the safety instructions!

Use only a dry cloth to clean the product.

## 5.9 Storage

Store the product in a dry and dust-free location when not in use. When transporting the product to the storage location, observe the instructions for transportation at the place of use (see the "Transporting the product at the place of use" section).



### **CAUTION**

#### **Risk of damage due to ambient factors!**

Excessive humidity, dust or high temperatures can affect the product's components and lead to malfunctions.

- Always store the product in locations that meet the required ambient conditions (see the "Technical data" section).

## 5.10 Disposal

Observe the safety instructions!

Always dispose of the product in accordance with all local disposal regulations.

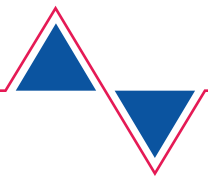

## 5.11 Maintenance

Follow the safety instructions!

Test the product at regular intervals to ensure proper functioning.



### WARNING

#### Danger of electric shock!

The electrical voltage in the product is dangerous and can cause serious injury or death from electric shock!

- Always make sure that you have the required qualification level for the maintenance work you are performing!

The product has been developed to be a low-maintenance device. To keep the product working reliably for many years, you must carry out inspections and maintenance at regular intervals. This section provides information about the following:

- Inspection and maintenance intervals
- Authorized inspection and maintenance personnel
- Inspection and maintenance areas on the product
- The inspection and maintenance table

### 5.11.1 Inspection and maintenance intervals

The inspection and maintenance table prescribes the following intervals:

Abbrevia tion	Meaning
D	Daily
W	Weekly
M	Monthly
Y	Yearly

### 5.11.2 Authorized inspection and maintenance personnel

The inspection and maintenance table prescribes who is authorized to carry out each activity. The inspection and maintenance table prescribes the following qualification levels:

Abbrevia tion	Qualification level	Explanation
U	Instructed persons	Personnel with this qualification level are trained in the handling of electric vehicles and the required charging procedures.

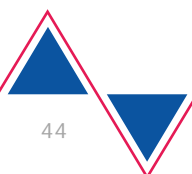

Abbrevia tion	Qualification level	Explanation
E	Electrician	Personnel with this qualification level have the professional training necessary to recognize and avoid hazards that can arise from electrical systems.
HV	High voltage	Personnel with this qualification level have the professional training necessary to recognize and avoid hazards that can arise from high-voltage systems.
ST	Stodia	Activities marked with this abbreviation may only be carried out by the manufacturer.

### 5.11.3 Inspection and maintenance areas on the product

The figure below shows the areas on the product that are subject to inspections and maintenance.

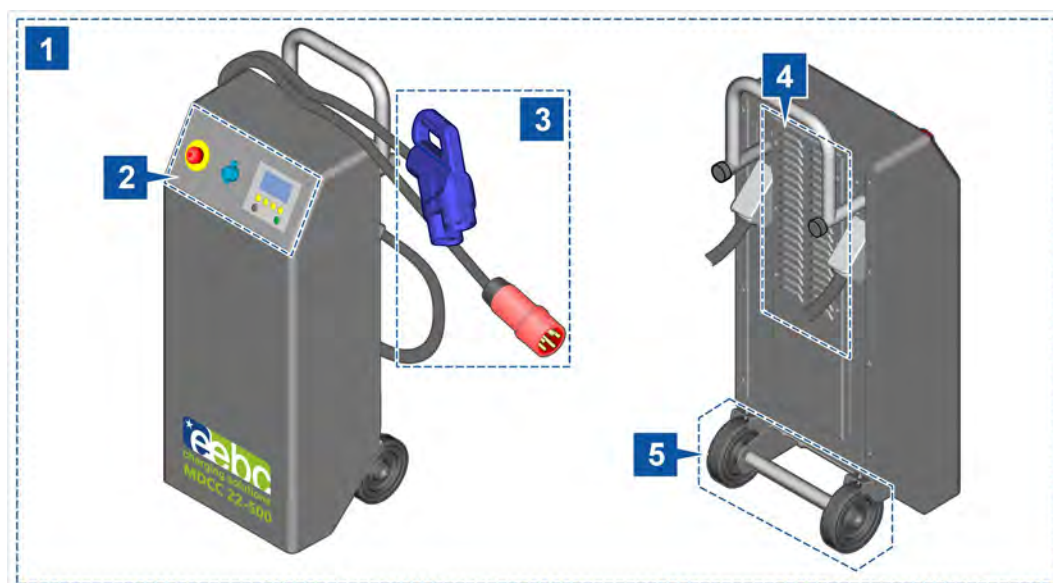

- (1) Entire product
- (2) Control panel
- (3) Plugs and cables
- (4) Ventilation grille
- (5) Wheels

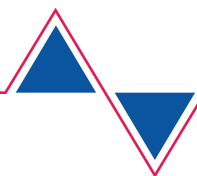

### 5.11.4 Inspection and maintenance table

The following table provides information about the inspections and maintenance to be carried out on the product, the corresponding intervals and the persons authorized to do so.

Area	Activity	Person	Interval
1	<b>Visual inspection</b> Check all stickers on the product to ensure that they are present, legible and not damaged. Inspect the plastic casing and the handles for damage.	U	W
	<b>Inspecting the housing screws</b> Inspect all screws on the housing, the handle and the wheels to make sure they are tight and none are missing. Tighten the screws if necessary.	HV	Y
	<b>Replacing product labels</b> Stickers must be replaced if they are damaged or insufficiently legible. <b>Important: Only the manufacturer can replace the warranty seal!</b>	HV	
	<b>Replacing the plastic casing</b> The plastic casing must be replaced if damaged.	ST	
2	<b>Visual inspection</b> Inspect the membrane keypad and the LC display to ensure they are legible and undamaged.	U	W
	<b>Replacing the membrane keypad and LC display</b> The LC display and membrane keypad must be replaced if they are insufficiently legible or their function is impaired.	ST	
	<b>Function test on emergency stop button</b> Test the function of the emergency stop button by pressing and resetting it (see the "Emergency stop button" section).	U	D
	<b>Replacing the emergency stop button</b> The emergency stop button must be replaced if its function is impaired.	ST	

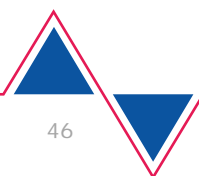

Area	Activity	Person	Interval
3	<b>Safety inspection</b> Inspect the plugs and electrical cables to ensure they meet electrical safety requirements.	E	W
	<b>Visual inspection</b> Inspect the plugs and electrical cables for damage.	U	D
	<b>Wear inspection</b> Inspect the plugs and electrical cables for wear. Check the number of mating cycles shown on the LC display (see the “Information parameters” section).	HV	W
	<b>Replacing the AC plug</b> The AC plug must be replaced if worn.	E ST	
	<b>Replacing the STS charging plug</b> The STS charging plug must be replaced if it is worn or has reached the maximum number of mating cycles.	ST	
4	<b>Function test of air filter mats</b> Inspect the air filter mats for dirt.	HV	M
	<b>Replacing the air filter mats</b> The air filter mats must be replaced if they are damaged or excessively dirty (see the “Replacing wearing parts” section).	HV	
5	<b>Function test</b> Inspect the wheels to ensure they are undamaged, securely attached and can rotate freely.  Check that the parking brake securely locks the wheels when the product is positioned vertically. If necessary, adjust the parking brake (see the “Adjusting the parking brake” section).	U	D
	<b>Wear inspection</b> Inspect the wheels and support bracket pads for wear.	HV	M
	<b>Replacing wearing parts</b> The wheels and support bracket pads must be replaced if they are worn (see the “Replacing wearing parts” section).	HV	

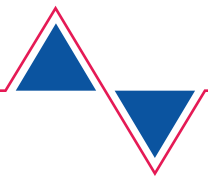

### 5.11.5 Tightening torques

The following table shows the maximum permissible torques for all screw connections. Observe the maximum torques when fastening components.

Screw size	M4	M5	M6	M8
Torque	2 Nm	3.5 Nm	6 Nm	16 Nm

### 5.11.6 Replacing wearing parts

This section explains how to replace wearing parts.

Certain wearing parts can be replaced only by the manufacturer or an electrician.

Use only original spare parts from the manufacturer.



#### CAUTION

##### Risk of injury due to heavy product!

Lifting the product can lead to back injuries.

Body parts can become trapped or crushed when the product is lowered.

- Always use two people to lift the product!
- Always wear protective footwear when transporting the product!



#### CAUTION

##### Risk of damage!

There is a risk of damaging wearing parts and threads.

- When tightening the screw connections, never exceed the specified maximum torque (see the “Tightening torques” section).



#### CAUTION

##### Risk of damage!

Products can be damaged if they fall.

- Always place the product on a workbench before performing maintenance work.
- Secure the product so that it cannot slip!

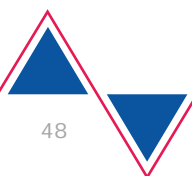



### Preparing the product

Before you can replace wearing parts, you have to prepare the product.

1. Disconnect the product from the power supply and from the vehicle.
2. Lift the product onto a workbench and make sure that it cannot slip. If necessary, set the product on a soft pad to protect it from scratches.
3. Coil the cables and place them next to the product. Make sure that the cables do not fall.

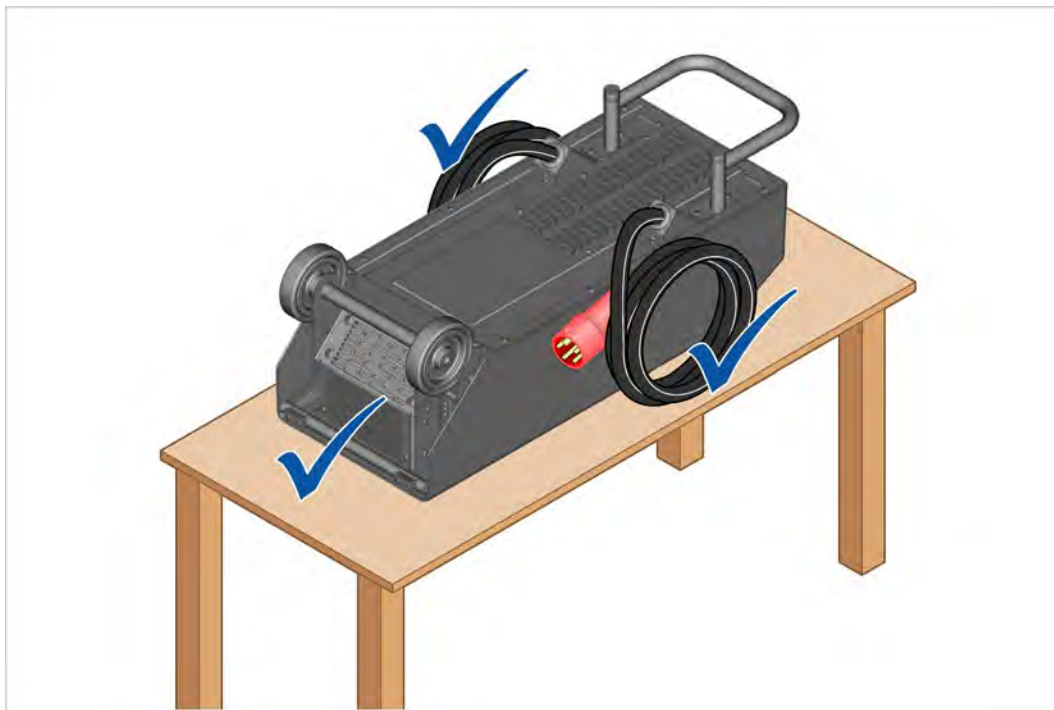

- ✓ The product is now ready for you to replace wearing parts.

## Replacing the upper filter mat

1. Remove the screws from the top cover.
2. Remove the top cover.
3. Replace the filter mat.
4. Reattach the top cover using the screws.

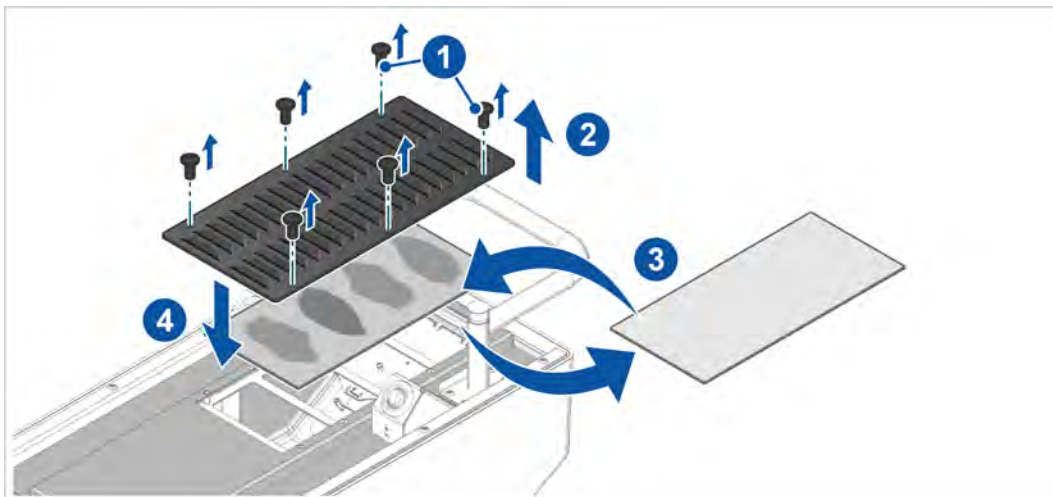

✓ You have successfully replaced the upper filter mat.

## Replacing the lower filter mat

1. Remove the screws from the bottom cover.
2. Remove the bottom cover.
3. Replace the filter mat.
4. Reattach the top cover using the screws.

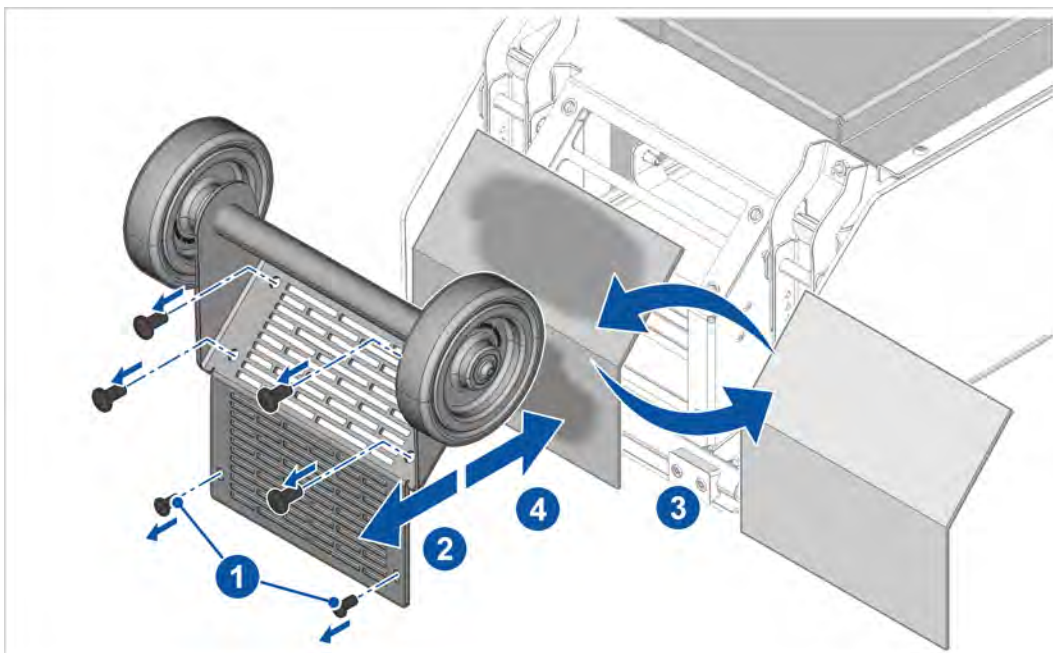

✓ You have successfully replaced the lower filter mat.

### Replacing the support bracket pads

Always replace both support bracket pads at the same time!

1. Remove the screws from the support bracket pads.
2. Replace the support bracket pads and fasten the new pads with the screws.

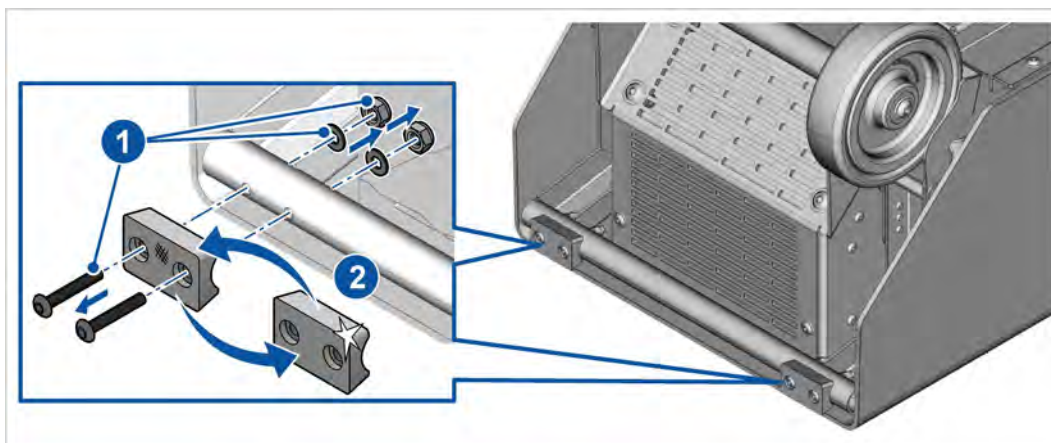

✓ You have successfully replaced the support bracket pads.

### Replacing the wheels

Always replace both wheels at the same time!

1. Remove the screw.
2. Remove the old wheel.
3. Replace the wheel.
4. Fasten the new wheel with the screw.
5. Adjust the parking brake if necessary (see the “Adjusting the parking brake” section).

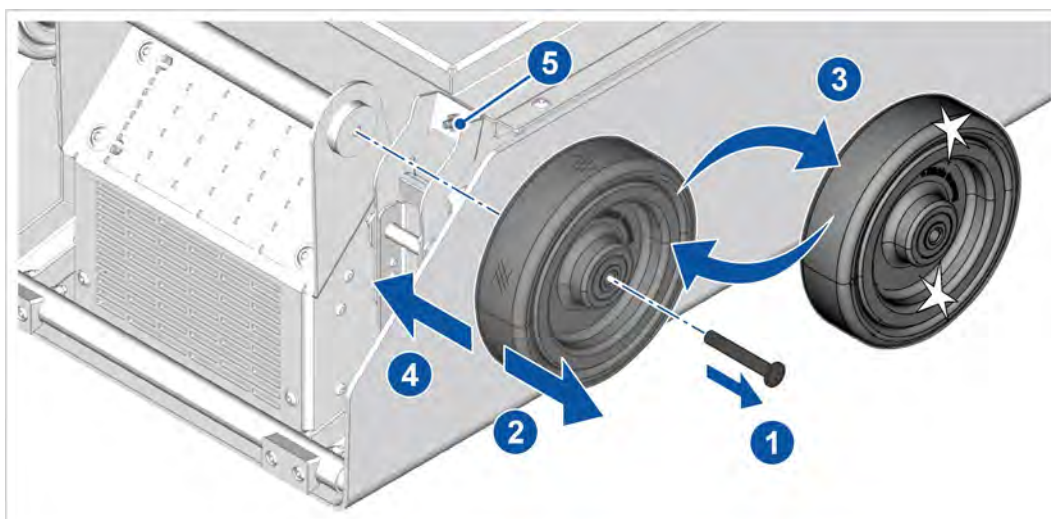

✓ You have successfully replaced the wheels.

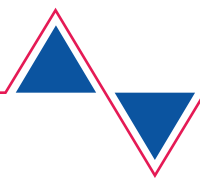

## 6 Help

---

### 6.1 Warranty

Stodia GmbH grants a warranty period of 24 months from the date of purchase. The warranty is valid for demonstrable defects in functional material and workmanship.

Further information on the warranty conditions can be found in the terms and conditions on the manufacturer's website.

### 6.2 Customer service

Always include the item number and, if available, the serial number with any product queries. Both numbers are found on the product.

Stodia GmbH  
Im Freitagsmoor 45  
38518 Gifhorn, Germany

Phone: +49 (0) 5373 – 92197-0

Fax: +49 (0) 5373 – 92197-88

[service@stodia.de](mailto:service@stodia.de)

[www.stodia.de](http://www.stodia.de)

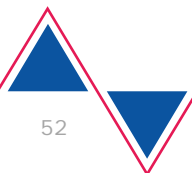



**Stodia GmbH  
Battery & Diagnostics Technology**

Im Freitagsmoor 45  
38518 Gifhorn, Germany

Phone: +49 (0) 53 73 / 92 197 – 0

Fax: +49 (0) 53 73 / 92 197 – 88

info@stodia.de

www.stodia.de

Translation of the original operating manual.

Subject to technical changes.



**EEBC European Electrical  
Bus Company GmbH**

Bessie-Coleman-Str. 7  
60549 Frankfurt am Main

www.eebc.gmbh

 **STODIA**<sub>GMBH</sub>

SPEICHER & DIAGNOSETECHNIK

