

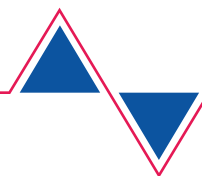

# Operating manual

Low voltage adapter cable Leavyseal Typ A

32.ST.2210.3057\_BA\_V01\_EN



Version	Date	Reason
<b>V00</b>	10.01.2022	First edition
<b>V01</b>	14.03.2022	Complete revision

## Legal notice

---

### Legal notice

#### Manufacturer

Stodia GmbH  
Battery & Diagnostics Technology  
Im Freitagsmoor 45  
38518 Gifhorn, Germany  
Phone: +49 (0) 5373 92197-0  
Fax: +49 (0) 5373 92197-88  
  
info@stodia.de  
www.stodia.de

#### Reproduction

Reproduction or reprinting, whether in whole or in part, always requires the written permission of the manufacturer.

#### Copyright

TRANSLATION OF THE ORIGINAL OPERATING MANUAL

All rights reserved.

All text, images and graphics are subject to copyright and other intellectual property laws.

Copyright 2022 Stodia GmbH.

#### Image sources

Symbols for warnings, prohibitions, mandatory actions and standards are taken from publicly accessible sources, such as the Internet. CAD product images and product photos are provided by the manufacturer. Images showing the product in use are provided with a reference to the source.

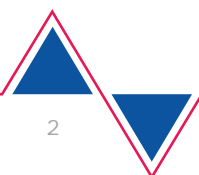

# Contents

---

<b>Contents .....</b>	<b>3</b>
<b>1 Introduction .....</b>	<b>4</b>
1.1 Preliminary information.....	4
1.2 Validity of the declaration of conformity .....	4
1.2.1 Addendum regarding declaration of conformity.....	4
1.3 Manufacturer specifications .....	4
<b>2 Safety .....</b>	<b>5</b>
2.1 Warning levels.....	5
2.2 Important safety instructions.....	5
2.3 Intended use .....	6
2.4 Requirements for the target group.....	7
2.5 Duties of the operator.....	7
<b>3 Product description .....</b>	<b>8</b>
3.1 Scope of delivery .....	8
3.2 Design .....	8
3.3 Symbols and connections.....	9
3.4 Wiring diagram .....	9
3.5 Displays and controls.....	10
3.6 Technical data .....	10
<b>4 Operation .....</b>	<b>11</b>
4.1 Startup.....	11
4.2 Detaching the plug connections .....	13
4.2.1 Detaching the plug connection for the diagnostic cable (Leavyseal) .....	13
4.3 Cleaning .....	13
4.4 Storage.....	14
4.5 Disposal .....	14
4.6 Maintenance .....	14
<b>5 Help .....</b>	<b>15</b>
5.1 Warranty.....	15
5.2 Customer service .....	15

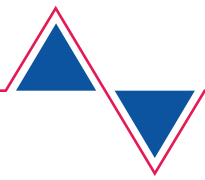

# 1 Introduction

## 1.1 Preliminary information

Read through this operating manual carefully before using the product.

The product is delivered with a USB stick containing the operating manual in various languages. You can find the current version and additional languages on our homepage.



There is a QR code on the product. You can scan this QR code with a device that is connected to the internet to go directly to the download area for your product.

The operating manual is an essential part of the product and must be kept together with the product. If you sell or transfer ownership of the product, the operating manual must be handed over to the new operator.

In addition to this operating manual, you must observe all relevant regulations for diagnostics or fault finding of intrinsically safe high-voltage systems in road vehicles. This includes but is not limited to: instructions for the vehicle manufacturer's diagnostics systems, company-specific safety requirements and the state of the art for working with high-voltage systems.

## 1.2 Validity of the declaration of conformity

The declaration of conformity applies to the product described in the operating manual. Any changes, modifications or extensions shall void the declaration of conformity and the risk assessment.

### 1.2.1 Addendum regarding declaration of conformity

The product is a customer-specific and application-specific trial product. The product has not yet undergone the full CE conformity procedure. Any CE markings on the product—like the product itself—are only intended as samples.

## 1.3 Manufacturer specifications



Since its founding, our company has focused on groundbreaking solutions for electromobility. Stodia GmbH develops and produces custom solutions for the automotive industry, the energy storage sector, repair shops and special vehicle fleets.

Our core products are innovative electrical storage systems, both stationary and mobile, which are essential technologies for advancing the energy revolution and energy autonomy. Stodia's portfolio also includes smart charging and battery technology, diagnostic systems, battery and cell management, and vehicle-wide measurement and diagnostic technology.

With experience in both software and hardware development, Stodia GmbH is your dependable partner at every production stage, from prototyping to series production.

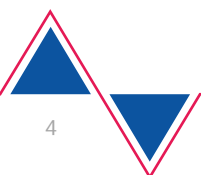

## 2 Safety

This operating manual is only valid for the following product:

Item number 22103057

Designation Low voltage adapter cable Leavyseal Typ A

### 2.1 Warning levels

This chapter provides information about the warning levels used in this operating manual.

#### **DANGER**

Failure to observe the safety instructions **WILL** result in death or serious injury!

#### **WARNING**

Failure to observe with the safety instructions **CAN** result in death or serious injury!

#### **CAUTION**

Failure to observe the safety instructions **CAN** result in minor physical injury!

### 2.2 Important safety instructions

This chapter contains the safety instructions that must be observed when handling the product.



#### **WARNING**

##### **Danger of fatal electric shock!**

The electrical voltage in other systems is lethal and can cause death by electric shock!

- Do not use the product for measurements on utility power circuits!
- Never attempt to power other devices with the product!



## WARNING

### Danger of fatal electric shock!

The electrical voltage in high-voltage systems is lethal and can cause death by electric shock!

Liquids, condensation and high humidity can cause short circuits!

- Do not let the product come into contact with liquids!
- Use the product only in dry and enclosed spaces!



## WARNING

### Danger of fatal electric shock!

Defective and damaged products can no longer guarantee protection against electrical voltage!

- Do not let the product come into contact with chemicals!
- Replace a defective or damaged product immediately!
- Never attempt to repair or tamper with the product!

## 2.3

### Intended use

Use the product only in accordance with this operating manual; otherwise the electrical hazard protection provided by the product can no longer be guaranteed.

The product is used to adapt battery management systems to the CelIDA. The CelIDA (**Cell Diagnosis and Analysis**) is a cell diagnostics and analysis station, a mobile service unit used for charging/discharging and analyzing high-voltage batteries in electric vehicles. The product can be used to perform diagnostics on high-voltage batteries connected to CelIDA.

The product is suitable for testing the following high-voltage batteries:

- BBP batteries.

Use the product only on approved high-voltage batteries! Consult the manufacturer regarding additional compatible batteries.

Any use beyond what is listed here is prohibited!

## 2.4

### Requirements for the target group

Only qualified personnel may work with this product!

In this operating manual, qualified personnel is defined as personnel meeting all requirements for working on high-voltage systems applicable in the country of operation, as defined by:

- Regulations applicable in the country of operation
- Qualification according to DGUV 200-005 level 2 or higher, or equivalent
- Specifications from the vehicle manufacturer and/or the operator.

In addition, the qualified personnel must be trained in the use of the product and all charging modes.

At all times while using the product, staff must wear the personal protective equipment prescribed by the vehicle manufacturer for work on high-voltage systems.

## 2.5

### Duties of the operator

The operator is responsible for ensuring that all staff working with the diagnostic cable fulfills the requirements for the target group.

Furthermore, the operator is responsible for ensuring the following:

- The diagnostic cable is always in perfect working order.
- The regular inspection intervals for the diagnostic cable are observed and recorded.

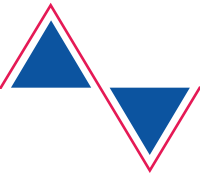

### 3 Product description

#### 3.1 Scope of delivery

Immediately check the condition of the product and the completeness of the delivery. If anything is missing or defective, please contact the manufacturer immediately.



- (1) Low voltage adapter cable
- (2) USB stick with operating manual

#### 3.2 Design

Product design:





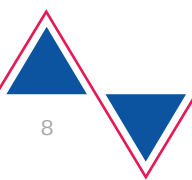

- (1) Plug for battery management system
- (2) Battery mode selector switch
- (3) Ground clip
- (4) CellDA plug





### 3.3 Symbols and connections

The following symbols are shown on the nameplate:

Symbol	Meaning
	Read the operating manual!
	Serial number of the product
	Disposal instruction
	QR code for accessing the operating manual on mobile devices.

### 3.4 Wiring diagram

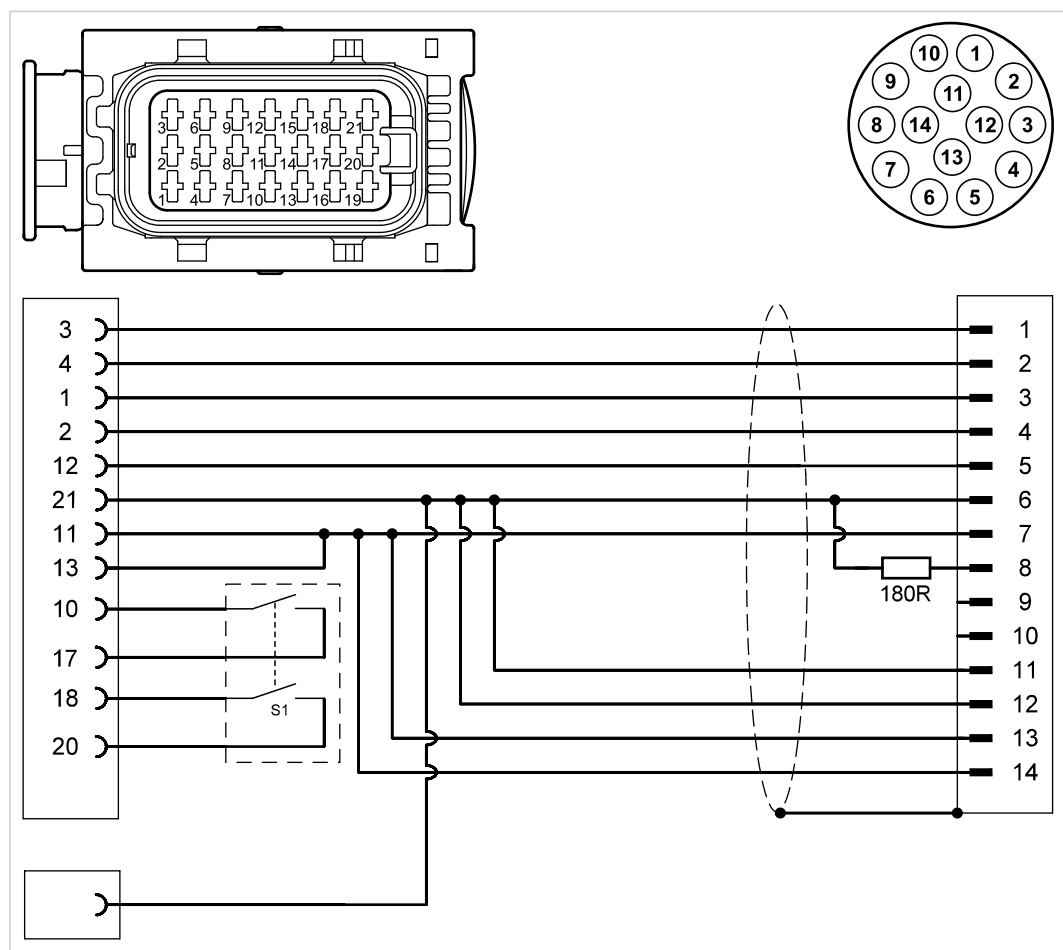

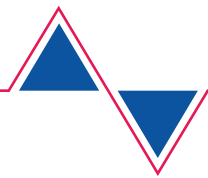

### 3.5 Displays and controls

The product has a battery mode selector switch.



Switch setting	Function
n. konf.	The battery can be switched to “not configured” mode.
MASTER	The battery can be switched to “MASTER” mode.

### 3.6 Technical data

Rated data	Values
Manufacturer number	22103057
Maximum rated voltage	DC 28 V
Maximum rated current	5 A
Weight	~ 370 g
Cable length	~ 5000 mm

Ambient conditions	Operation	Storage	Transportation
Temperature	5°C to 40°C	-20°C to 60°C	-20°C to 60°C
Elevation above sea level	Max. 2000 m	No limitation.	
Humidity	Max. 80% up to 31°C, decreasing linearly to 50% at 40°C	Max. 85%	
Condensation not permitted. Maximum permissible relative humidity: 60% in environments with corrosive gas/air.			

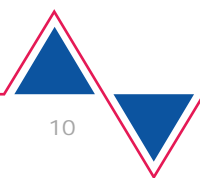

## 4 Operation

This chapter provides information about the following activities:

- Startup
- Detaching the plug connection
- Cleaning
- Storage
- Disposal
- Maintenance

### 4.1 Startup

This section provides you with information about starting up and operating the product.



#### WARNING

##### Danger of fatal electric shock!

The electrical voltage in high-voltage systems is lethal and can cause death by electric shock!

- Use the product only for the applications intended by the vehicle manufacturer!



#### CAUTION

##### Risk of damage!

Plug connections lock into place when attached.

- Unlock the plug connections before you detach them! (See chapter “Detaching the plug connections”)

1. Follow the safety instructions.



2. Connect the ground clip to a conductive part of the vehicle body. If the traction battery has been removed from the electric vehicle, connect the ground terminal to a conductive part of the traction battery housing.
3. Connect the low-voltage plug to the disconnected socket on the battery management system.
4. Lock this connection.
5. Switch the selection switch to the "MASTER" setting.

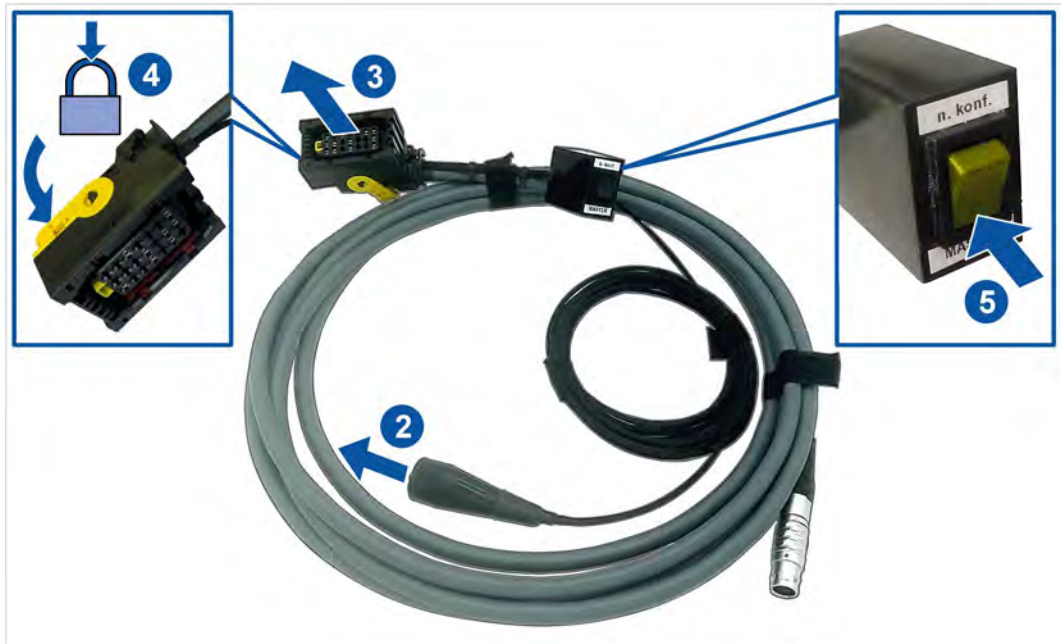

6. Connect the CellIDA plug to the socket on the back of the CellIDA.  
Make sure that the color markings (red) are aligned and that you hear the plug lock into place.

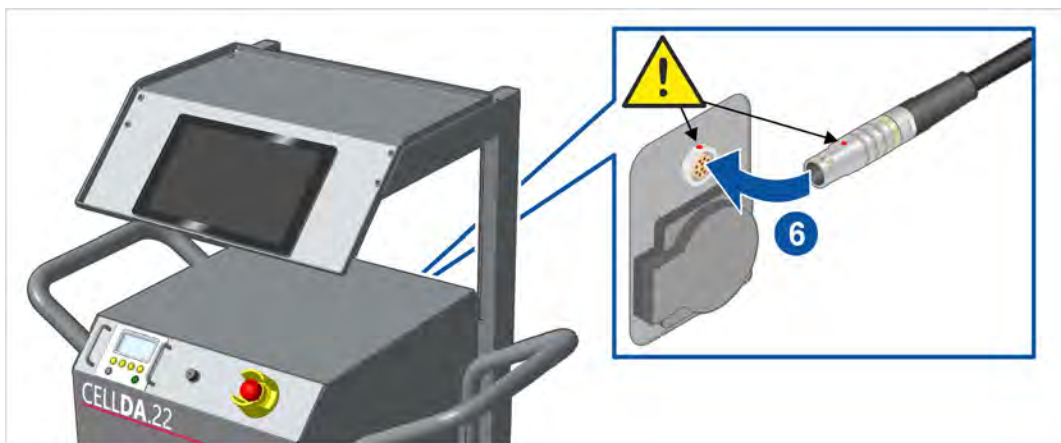

- ✓ The battery management system is now connected to the CellIDA.
- ✓ You can now run diagnostics with the CellIDA.

## 4.2 Detaching the plug connections



### WARNING

#### Risk of explosion!

Product components may produce sparks and electric arcs.

- Do not use the product in potentially explosive atmospheres!

### 4.2.1 Detaching the plug connection for the diagnostic cable (Leavyseal)

The plug connection has a locking mechanism. To detach a plug connection:

7. Pull out the locking mechanism.
8. Pull the plug connection apart.

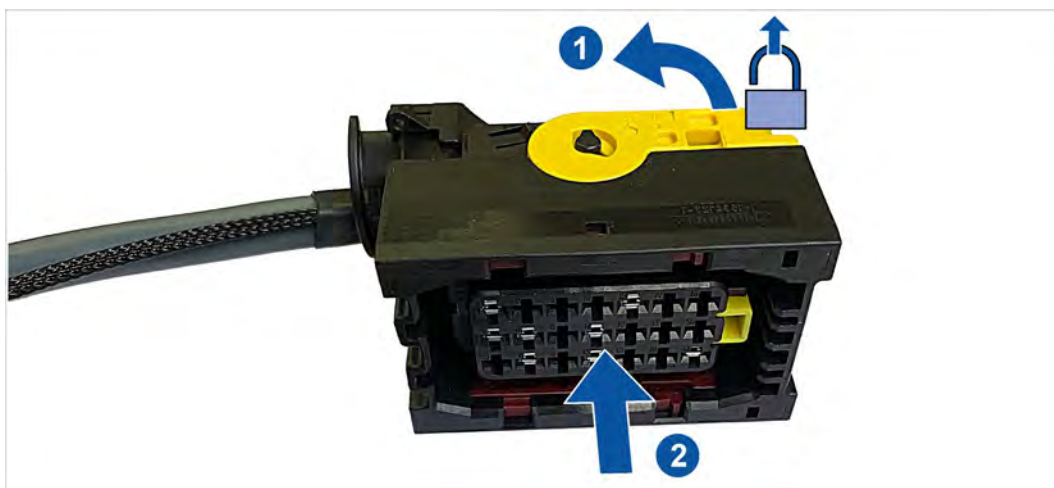

✓ The plug connection is now detached.

## 4.3 Cleaning



### DANGER

#### Danger of fatal electric shock!

The electrical voltage in high-voltage systems is lethal and will cause death by electric shock!

- Disconnect the product from all power sources before cleaning the product!

Observe the safety instructions!

Use only a dry cloth to clean the product.

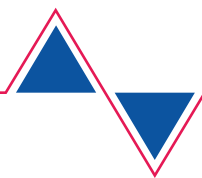

### 4.4 **Storage**

Store the product in a dry and dust-free location when not in use. Observe the permitted ambient conditions (see the “Technical data” section).

### 4.5 **Disposal**

Observe the safety instructions!

Always dispose of the product in accordance with all local disposal regulations.

### 4.6 **Maintenance**

Observe the safety instructions!

National and local requirements for regular testing must be observed!

Test the product for proper function at intervals of no more than 24 months.

Contact the manufacturer to have a professional function test performed.

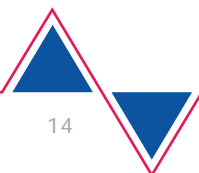

## 5 Help

---

### 5.1 Warranty

Stodia GmbH grants a warranty period of 24 months from the date of purchase. The warranty is valid for demonstrable defects in functional material and workmanship.

Further information on the warranty conditions can be found in the terms and conditions on the manufacturer's website.

### 5.2 Customer service

Always include the serial number with any product queries. This number is found on the product.

Stodia GmbH  
Battery & Diagnostics Technology  
Im Freitagsmoor  
38518 Gifhorn, Germany

Phone: +49 (0) 5373 – 92197-0

Fax: +49 (0) 5373 – 92197-88

[service@stodia.de](mailto:service@stodia.de)

[www.stodia.de](http://www.stodia.de)

---

**Stodia GmbH**  
**Battery & Diagnostics Technology**

Im Freitagsmoor 45  
38518 Gifhorn, Germany

Phone: +49 (0) 53 73 / 92 197 – 0  
Fax: +49 (0) 53 73 / 92 197 – 88

info@stodia.de  
www.stodia.de

Translation of the original operating manual.  
Subject to technical changes.



**STODIA**<sub>GMBH</sub>  
SPEICHER & DIAGNOSETECHNIK



---